

SECTION A-A

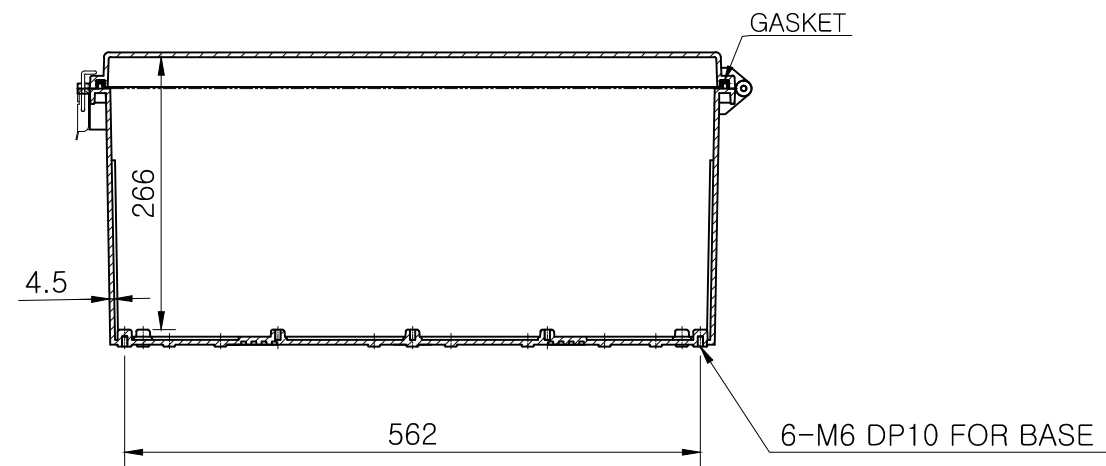
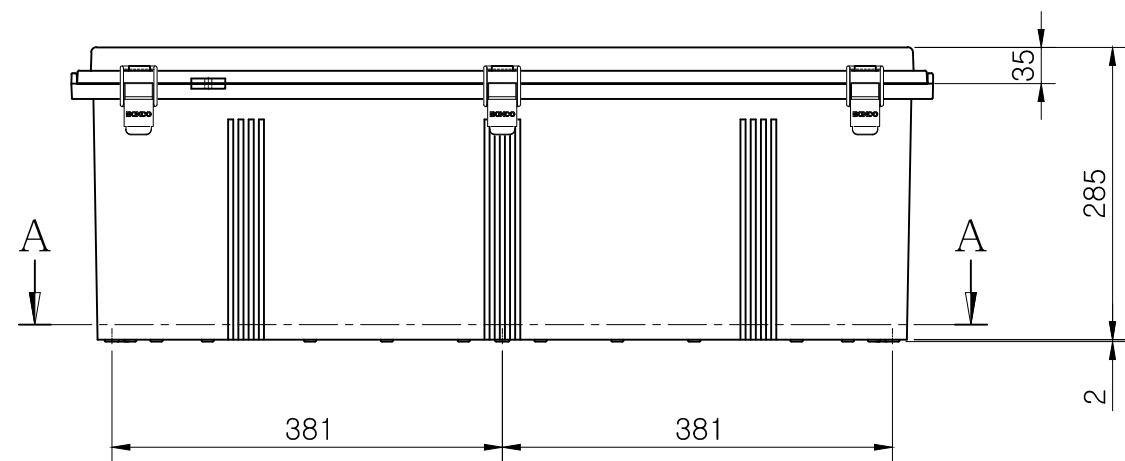

SECTION B-B

Note.

MODEL (모델)	BC-□□P-608028	D R (제 도)	JUNG,Y.J.	16.05.12	UNIT (단 위)	mm	
ASSY (완성 규격)	630 * 830 * 285	C K (검 도)	PARK,Y.J.	16.05.12	SCALE (척 도)	1:7	
DWG NO (도 번)	P-608028-03	MATERIAL (재 질)	A P (승 인)	KIM,D.S.	16.05.13	REV. (개 정)	0

