

DMX-SPI-203 LED Controller



DMX-SPI-203 controls LED with the following compatible ICs: LPD6803, LPD1101, D705, UCS6909, UCS6912, LPD8803, LPD8806, TM1803, TM1804, TM1809, TM1812, UCS1903, UCS1909, UCS1912, UCS2903, UCS2909, UCS2912, TLS3001, TLS3002, WS2801, WS2803, WS2811, WS2812, P9813.

Supporting international standard protocol DMX512/1990 interface, with DMX administration mode to invoke the built-in functions for choosing mode, speed, brightness, types and direction changing by DMX512 console. Furthermore, it has the DMX decode mode, customers could use DMX512 console to program & control every channel of the LEDs with the compatible ICs listed above. 0-100% dimming range, program any lighting effect required.

1. Product Parameter:

DMX-SPI-203 Controller:

- | | |
|---|--|
| • Input Voltage: 5~24Vdc | • Control Qty: 1024 Pixels |
| • Power Consumption: 1W (if the lamps are powered individual) | • Virtual Pixel: 1-6 times, Max 1024 pixel |
| • Output Signal: SPI(TTL) | • Working Temperature: -30°C ~ 55°C |
| • Change Mode: 540 | • Dimensions: L175×W44×H30(mm) |
| • DMX Channel: DMX Manage Mode: 6CH | • Package Size: L178×W48×H33(mm) |
| DMX Decode Mode: 510CH | • Weight(G.W.): 130g |

M203 Remote

- Working Voltage: 3V(battery CR2032)
- Working Frequency: 2.4GHz
- Working Temperature: -20°C~55°C
- Dimensions: L104×W58×H9(mm)
- Weight(N.W.): 42g

Package Dimensions: L228xW156xH35(mm)

Total Weight(G.W.): 240g

2. Product Dimension:

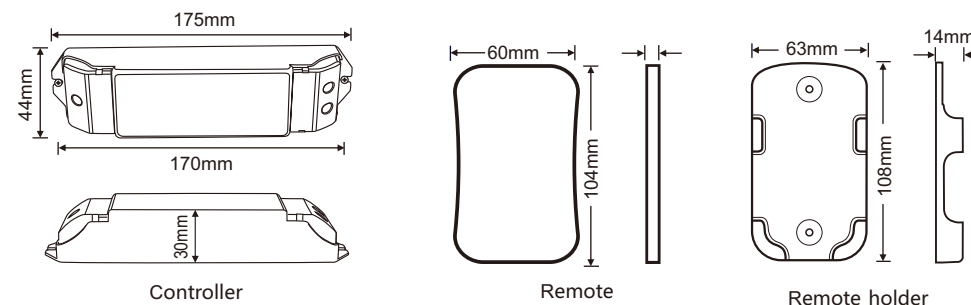

3. Terminal Description:

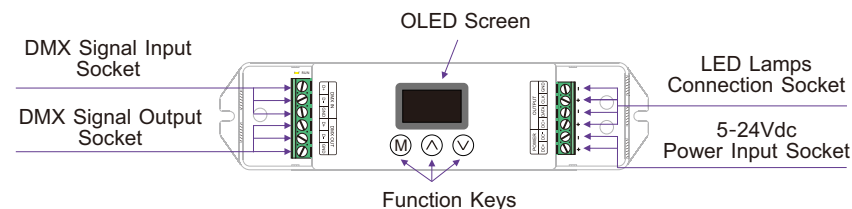

4. M203 Remote:

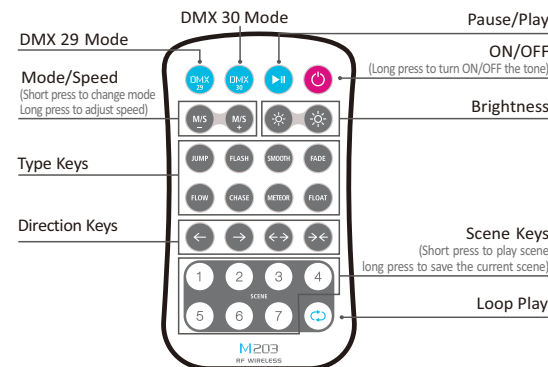

The Learning Remote Method:

The controller and remote are Pre-synced at factory. If deleted accidentally, the sync method is as follows.

Firstly, press M Key on the controller to enter the setting interface. Secondly, press M Key again to switch to "Remote Match" entry.

Then Press "▲" or "▼" button to enter remote learning interface: Press any key on the remote control to match with the controller.

Long press "▲" or "▼" button to delete ID, which cancels the match.

(multiple remotes could be synced to one controller):

5. OLED Screen Interface Diagram:

Press "M" key, switch entries.
 Press "▲" or "▼" key, adjust parameters.
 Exit: Return to the previous menu.
 Long press "M" key, return to the main display interface(Figure 1).

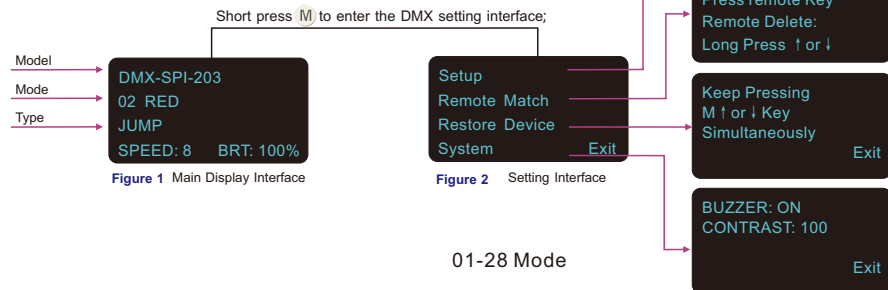

01-28 Mode

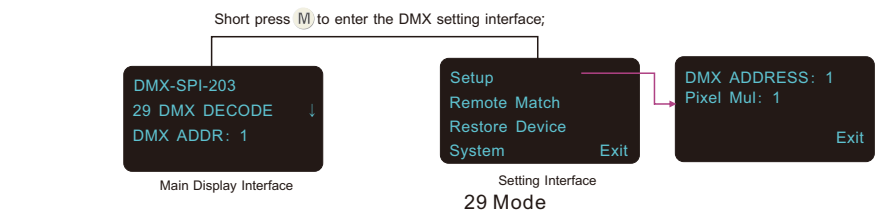

29 Mode

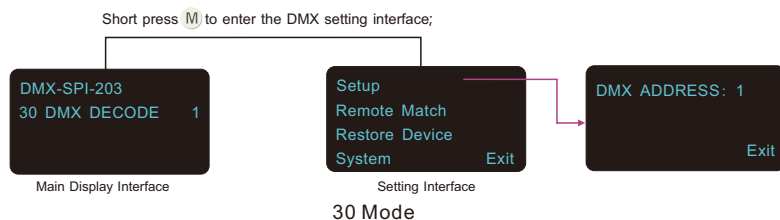

30 Mode

Table of Changing Modes

No.	Changing Color	No.	Changing Color	No.	Changing Color	No.	Changing Color	No.	Changing Color	No.	Changing Color
1	BLA(black)	6	PUR(purple)	11	B/W(blue/white)	16	R/P(red/purple)	21	Y/P(yellow/purple)	26	G/B(green/blue)
2	RED(red)	7	GYN(cyan)	12	Y/W(yellow/white)	17	G/Y(green/yellow)	22	Y/C(yellow/cyan)	27	RGB
3	GRN(green)	8	WHI(white)	13	P/W(purple/white)	18	G/C(green/cyan)	23	P/C(purple/cyan)	28	ALL(all color)
4	BLU(blue)	9	R/W(red/white)	14	C/W(cyan/white)	19	B/P(blue/purple)	24	R/G(red/green)	29	DMX decode
5	YLW(yellow)	10	G/W(green/white)	15	R/Y(red/yellow)	20	B/C(blue/cyan)	25	R/B(red/blue)	30	DMX mode

Display [DMX-SPI-203 Cycle] after 30 mode: Cycle play scene of 1-7.

In 2-28 modes, you can use the remote control to choose light changing types (JUMP, FLASH, SMOOTH, FADE, FLOW, CHASE, METEOR, FLOAT) and light moving directions(←, →, ↔, ↔), which compose 540 kinds of changing modes

Instruction of DMX console in Mode 29

Function Modes	Channel	Function
29 DMX Decoder Mode	1 st channel	0-255(R) : Red LED 0-100% dimming
	2 nd channel	0-255(G) : Green LED 0-100% dimming
	3 rd channel	0-255(B) : Blue LED 0-100% dimming

Instruction of DMX console in Mode 30

in **Mode 30**, when connected to DMX console, could use 6 channels to manage color, speed, brightness, types, direction and flash of all modes.

Channel	Function	Channel	Function
CH1(0-223):	Select 1-28 modes.	CH1(224-255)	Select 29 mode.
CH2(0-255):	Adjust changing speed of mode 1-28(8 levels).	CH2(0-255):	Red LED 0-100% dimming
CH3(0-255):	Adjust brightness of mode 1-28 (8 levels).	CH3(0-255):	Green LED 0-100% dimming.
CH4(0-255):	Select 8 changing types of mode 1-28 (jump, flash smooth, fade, flow, chase, meteor, float)	CH4(0-255):	Blue LED 0-100% dimming.
CH5(0-255):	Select 4 changing direction of mode 1-28 forward (↑), reverse (↓), close (X), split(⚡)		
CH6(0-255):	Flashing speed option for mode 1-28		

6. Wiring Diagram:

Wiring Method	Signal Cable	Compatible ICs
	Two cables DATA CLK	LPD6803, LPD1101, D705, UCS6909, UCS6912, LPD8803, LPD8806, WS2801, WS2803, P9813, GS8206(BGR), SM16703, APA102
	Single cable DATA	Tm1803, TM1804, TM1809, TM1812, UCS1903, UCS1909, UCS1912, UCS2903, UCS2909, UCS2912, WS2811, WS2812, TLS3001, TLS3002, APA104, KL592D, SK6812, TM1914, TM1914A

6.1 DMX-SPI-203 as master console:



6.2 Connection with DMX console:



6.3 LED pixel strip wiring diagram:

a. Conventional connection method.

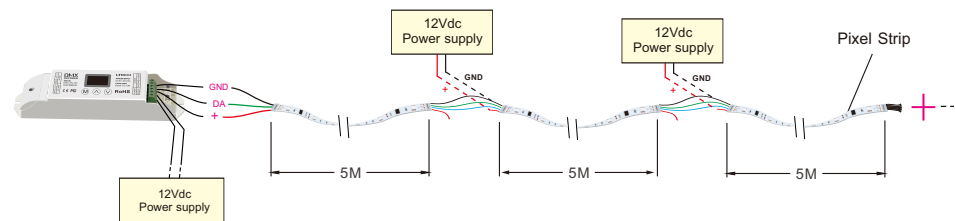

b. Light fixtures and controller using different operating voltages.

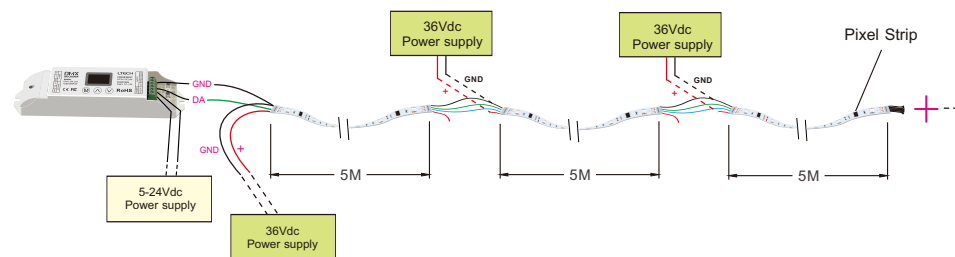

6.4 Connected with DMX computer console to realize decoder function:

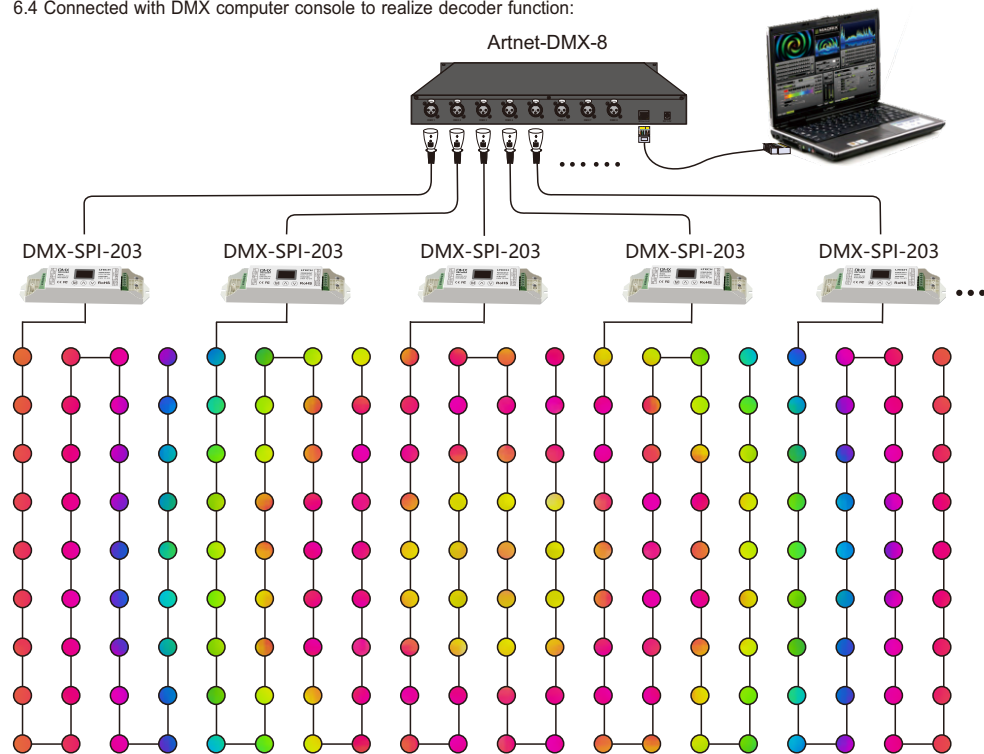

7. Attention:

1. The product shall be installed and serviced by the qualified person.
2. This product is non-waterproof. Please avoid the sun and rain. When installed outdoors please ensure it is mounted in a water proof enclosure.
3. Good heat dissipation will prolong the working life of the controller. Please ensure good ventilation.
4. Please check if the output voltage of the LED power supply used comply with the working voltage of the product.
5. Please ensure that adequate sized cable is used from the controller to the LED lights to carry the current. Please also ensure that the cable is secured tightly in the connector.
6. Ensure all wire connections and polarities are correct before applying power to avoid any damages to the LED lights.
7. If a fault occurs please return the product to your supplier. Do not attempt to fix this product by yourself.

8. Warranty Agreement:

1. We provide lifelong technical assistance with this product:
 - A 5-year warranty is given from the date of purchase. The warranty is for free repair or replacement if cover manufacturing faults only.
 - For faults beyond the 5-year warranty we reserve the right to charge for time and parts.
 2. Warranty exclusions below:
 - Any man-made damages caused from improper operation, or connecting to excess voltage and overloading.
 - The product appears to have excessive physical damage.
 - Damage due to natural disasters and force majeure.
 - Warranty label, fragile label and unique barcode label have been damaged.
 - The product has been replaced by a brand new product.
 3. Repair or replacement as provided under this warranty is the exclusive remedy to the customer. LTECH shall not be liable for any incidental or consequential damages for breach of any stipulation in this warranty.
 4. Any amendment or adjustment to this warranty must be approved in writing by LTECH only.
- ★This manual only applies to this model. LTECH reserves the right to make changes without prior notice.