

SECTION A-A

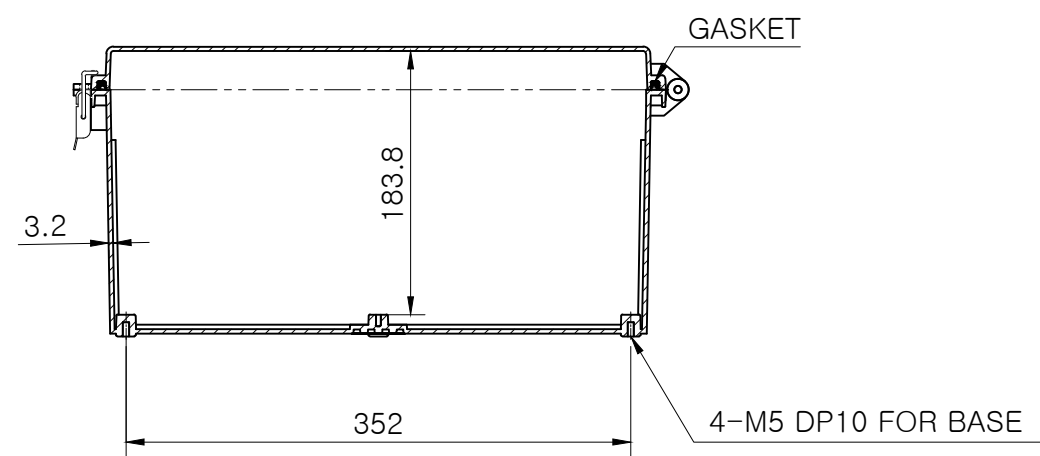
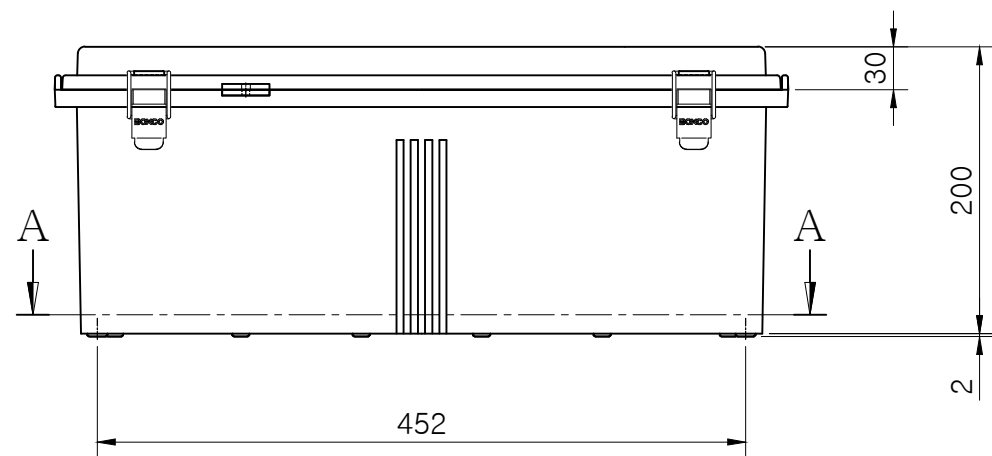

SECTION B-B

Note.

MODEL (모델)	BC-□□P-405020	D R (제 도)	JUNG,Y.J.	16.05.02	UNIT (단 위)	mm	
ASSY (완성 규격)	401 * 501 * 200	C K (검 도)	PARK,Y.J.	16.05.02	SCALE (척 도)	1:5	
DWG NO (도 번)	P-405020-03	MATERIAL (재 질)	A P (승 인)	KIM,D.S.	16.05.03	REV. (개 정)	0

BOXCO[®]