

SECTION A-A

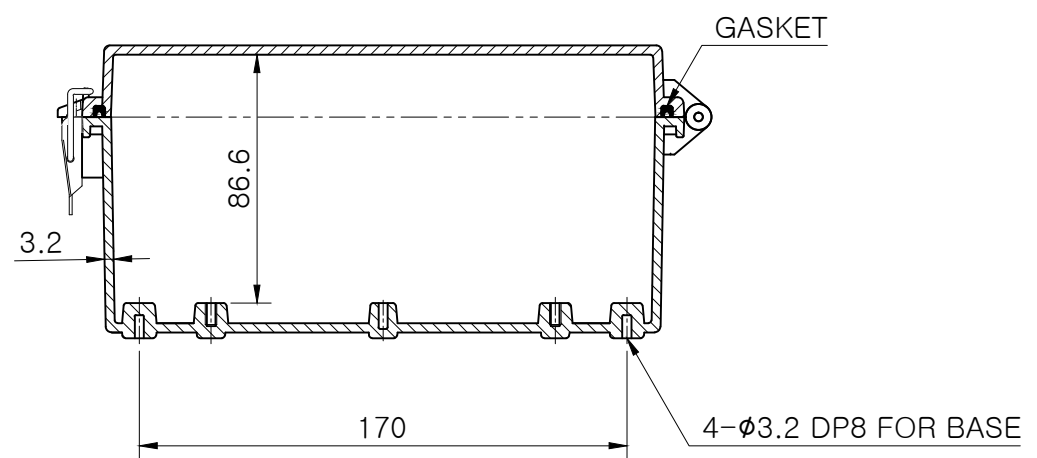
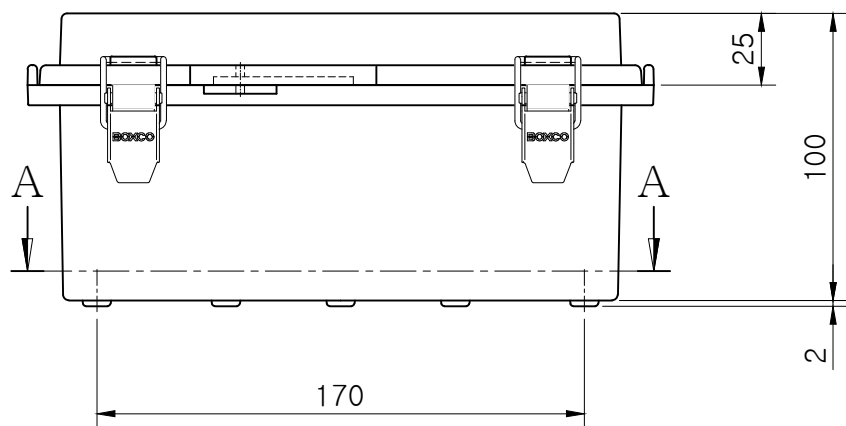

SECTION B-B

Note.

MODEL (모델)	BC-□□P-212110	D R (제도)	JUNG,Y.J.	16.04.12	UNIT (단위)	mm	
ASSY (완성 규격)	210 * 210 * 100	C K (검도)	PARK,Y.J.	16.04.12	SCALE (척도)	1:2.5	
DWG NO (도번)	P-212110-03	MATERIAL (재질)	A P (승인)	KIM,D.S.	16.04.13	REV. (개정)	0

**BOXCO**<sup>®</sup>