



## Features

- EIB / KNX power supply with integrated choke
- Compact size with 4SU width(72mm)
- Safety extra low voltage(SELV)
- Suitable for TP1-256
- 180~264VAC input
- Protections: Short circuit / Overload(short-circuit-proof)/ Over voltage
- Cooling by free air convection
- Isolation class I
- LED indicator for normal operation, bus reset and bus overload
- Monitoring of output voltage,output current,bus traffic load and device temperature
- Provide Wide variety of diagnostic and logic function
- Over Voltage category III
- 3 years warranty

## Applications

- Intelligent home control
- Modern building automation
- Lighting control
- HVAC system
- Security system
- Blinds and shutters
- Monitoring systems
- Energy management
- Alarm monitoring

## Description

MEAN WELL,the leading standard power supply manufacturer,continues to promote the buiding automation technology for making a green and sustainable society.After the launch of KNX-20E-640,the new KNX power supply KNX-40E-1280(D) is proudly introduced.

The KNX Power Supply KNX-40E-1280(D) is a 1280mA power supply with high efficiency and a small footprint of only 4SU(72mm).The device has a KNX bus choke output and additional output for auxiliary power.The -30~+70°C wide temperature operating range can meet all kinds of applications.For troubleshooting,monitoring purpose,output voltage,output current,bus traffic,device temperature and other actual measurement values can be sent via KNX.LED indicators are used in case of normal operation,overload conditions and RESET operation.It is perfectly suitable to power up any products labeled with the KNX trademark.

## Model Encoding

KNX - 40 E - 1280

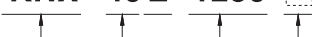

Blank: basic function; D: with diagnostic function

Output current

Output wattage

Series name

Type	Function	Note
Blank	1280mA KNX Power Supply	In Stock
D	1280mA KNX Power Supply with Diagnostic function	In Stock



**SPECIFICATION**

<b>MODEL</b>		<b>KNX-40E-1280</b> <input type="checkbox"/>
<b>OUTPUT</b>	<b>BUS OUTPUT VOLTAGE WITH CHOKE</b>	Bus,30V (KNX black/red terminal block)
	<b>DC OUTPUT VOLTAGE WITHOUT CHOKE</b>	30V(Additional output for ancillary power)
	<b>RATED CURRENT</b>	1280mA
	<b>RATED POWER</b>	38.4W
	<b>RIPPLE &amp; NOISE</b> (max.) Note.2	100mVp-p
	<b>SHORT CIRCUIT CURRENT</b>	2.8A
	<b>SETUP, RISE TIME</b>	1000ms, 50ms/230VAC at full load
	<b>AC MAINS FAILURE BACK-UP TIME</b> (Typ.)	200ms/230VAC at full load
<b>INPUT</b>	<b>VOLTAGE RANGE</b>	180 ~ 264VAC      176 ~ 280VDC
	<b>FREQUENCY RANGE</b>	47 ~ 63Hz
	<b>EFFICIENCY</b> (Typ.) Note.3	86%
	<b>AC CURRENT</b> (Typ.)	0.5A/230VAC
	<b>INRUSH CURRENT</b> (Typ.)	COLD START 60A(twidth=1200μs measured at 50% Ipeak)/230VAC
	<b>LEAKAGE CURRENT</b>	<1mA / 240VAC
<b>PROTECTION</b>	<b>OVERLOAD</b>	205 ~ 235% rated output power Protection type : Constant current limiting, recovers automatically after fault condition is removed
	<b>OVER VOLTAGE</b>	33 ~ 35V Protection type : Hiccup mode, recovers automatically after fault condition is removed
<b>FUNCTION</b>	<b>RESET</b>	Physical button for the bus reset: Blank type:Press the RESET button for at least 20 seconds to reset the KNX Bus D type:Press the RESET button once,it will reset the KNX Bus last for 20 seconds automatically
	<b>LED INDICATORS</b>	Please refer to the "Explanation of LED Status"
	<b>CHOKE</b>	One integrated choke
<b>ENVIRONMENT</b>	<b>WORKING TEMP.</b>	-30 ~ +70°C (Refer to "Derating Curve")
	<b>WORKING HUMIDITY</b>	20 ~ 95% RH non-condensing
	<b>STORAGE TEMP., HUMIDITY</b>	-40 ~ +85°C, 10 ~ 95% RH non-condensing
	<b>VIBRATION TYPE OF PROTECTION</b>	10 ~ 500Hz, 2G 10min./1cycle, 60min. each along X, Y, Z axes
	<b>TYPE OF PROTECTION</b>	IP20 design
	<b>OVER VOLTAGE CATEGORY</b>	III ,According to EN61558, EN50178,altitude up to 2000 meters
<b>SAFETY &amp; EMC</b> (Note 4)	<b>SAFETY STANDARDS</b>	EN61558-1,EN61558-2-16 ; EN50491-3 approved
	<b>WITHSTAND VOLTAGE</b>	I/P-O/P:4.2KVAC    I/P-FG:2KVAC
	<b>ISOLATION RESISTANCE</b>	I/P-O/P, I/P-FG:100M Ohms / 500VDC / 25°C/ 70% RH
	<b>EMC EMISSION</b>	Compliance to EN50491-5-2,-5-3;EN61000-3-2,-3-3
<b>OTHERS</b>	<b>EMC IMMUNITY</b>	Compliance to EN50491-5-2,-5-3 ; EN61000-4-2,3,4,5,6,8,11, heavy industry level, criteria A
	<b>MTBF</b>	487.4K hrs min. Telcordia SR-332 (Bellcore)      215.6Khrs min.    MIL-HDBK-217F (25°C)
	<b>DIMENSION</b>	72*90*57mm (W*H*D)
	<b>MOUNTING</b>	35mm mounting rail according to DIN EN60715
	<b>PACKING</b>	0.328Kg ; 48pcs/16.4Kg/1.02CUFT
<b>NOTE</b>	<p>1. All parameters NOT specially mentioned are measured at 230VAC input, rated load and 25°C of ambient temperature.</p> <p>2. Ripple &amp; noise are measured at 20MHz of bandwidth by using a 12" twisted pair-wire terminated with a 0.1uf &amp; 47uf parallel capacitor. Measure before Choke.</p> <p>3. Efficiency before choke.</p> <p>4. The power supply is considered a component which will be installed into a final equipment. The final equipment must be re-confirmed that it still meets EMC directives. For guidance on how to perform these EMC tests, please refer to "EMI testing of component power supplies." (as available on <a href="http://www.meanwell.com">http://www.meanwell.com</a>)</p> <p>5. The ambient temperature derating of 3.5°C/1000m with fanless models and of 5°C/1000m with fan models for operating altitude higher than 2000m(6500ft).</p>	

### Block Diagram

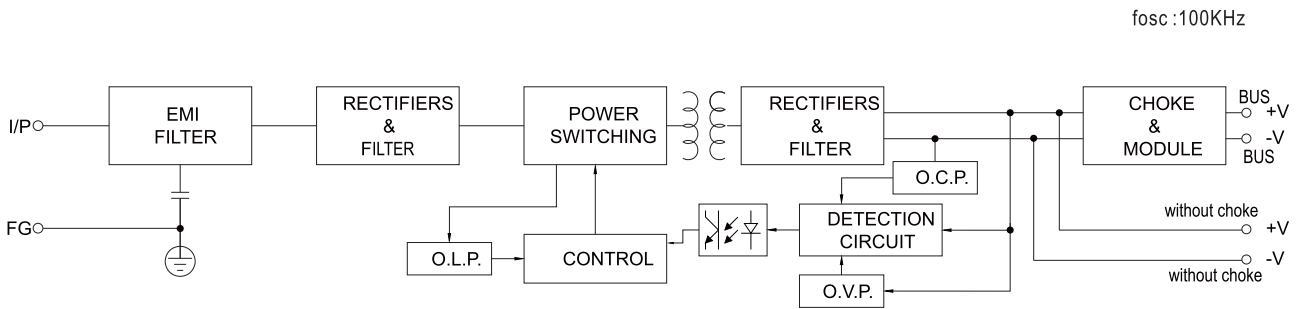

### Derating Curve

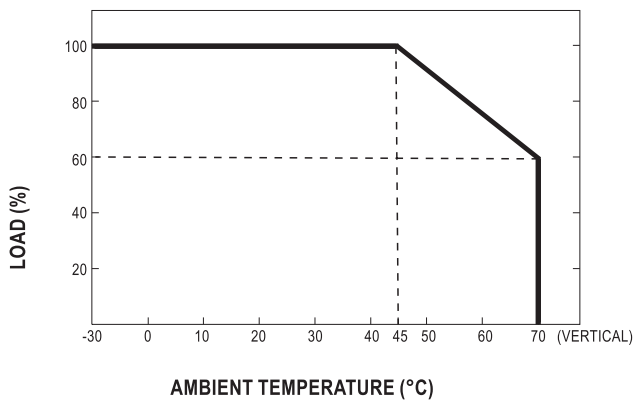

### Static Characteristics

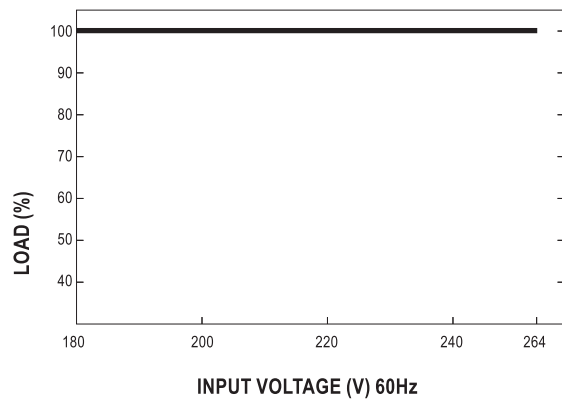

## Mechanical Specification

### ※ Blank-Type

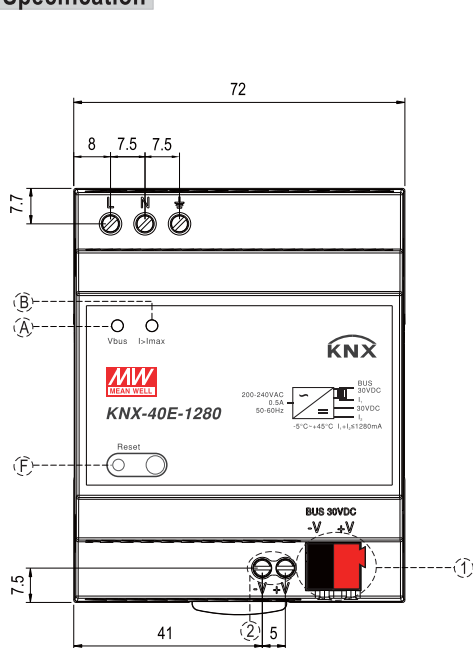

1	KNX bus terminals (Red :+, DARK-GRAY:-)
2	Ancillary power terminals

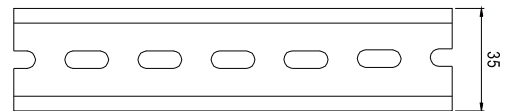
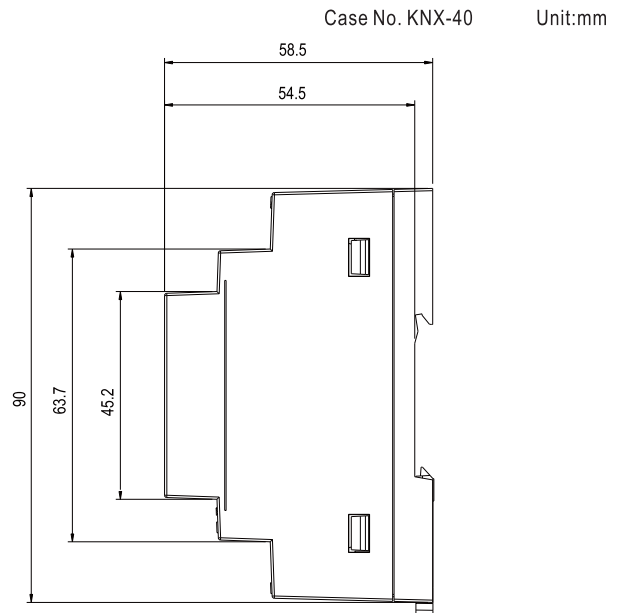

ADMISSIBLE DIN-RAIL: TS35/7.5 OR TS35/15

### ※ D-Type

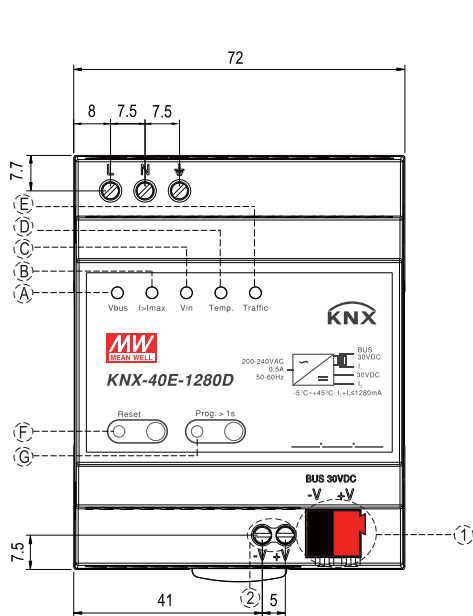

1	KNX bus terminals (Red :+, DARK-GRAY:-)
2	Ancillary power terminals

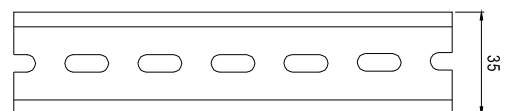
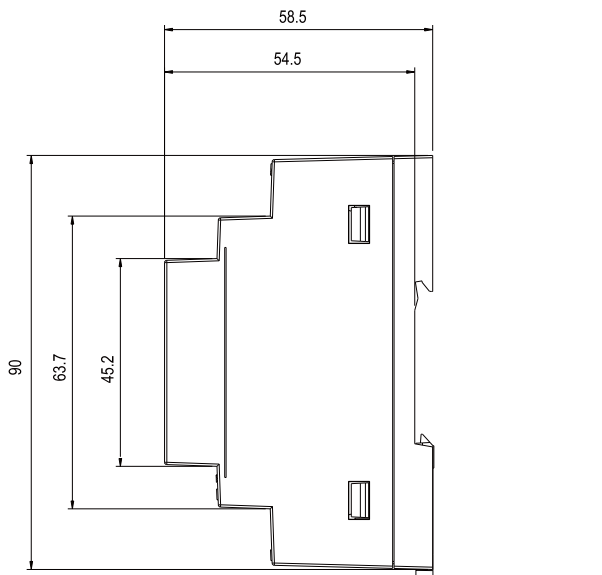

ADMISSIBLE DIN-RAIL: TS35/7.5 OR TS35/15

■ **Explanation of LED Status**

Number	LED light	Color, Indicate type	Explanation / Range
A	Bus voltage $V_{BUS}$	Green, constant	KNX Bus voltage is 28~31VDC
		Red, constant	KNX Bus voltage lower than 28VDC
		Orange, constant	KNX Bus voltage higher than 31VDC
B	Output current $I_{OUT}$	Green, constant	Output current < 1280mA
		Orange, constant	Output current is 1280mA~1600mA
		Red, constant	Output current >1600 mA (Overload)
C	Power Input $V_{IN}$	Green, constant	Powered by AC input
		Green, flash	Powered by DC input
		Red, constant	AC/DC input fail
D	Internal Temperature	Green, constant	Internal Temperature is 0~75 °C
		Red, constant	Internal Temperature is out of this range
E	Telegram traffic	Green, flash	Telegram load < 80 %
		Red, constant	Telegram load >= 80 %
F	KNX Reset	Red, constant	Device is during a KNX bus restart
G	Programming	Red, constant	Device in Program mode

■ **Configuration and Commissioning**

The application program (database) can be downloaded via Online Catalogs from ETS or via <http://www.meanwell.com/productCatalog.aspx>

■ Communication Object Table (Only for KNX-40E-1280D)

Num	Object name	Object function	Length	DPT	Priority	Flag
1	Heartbeat	Send info	1bit	1.017,trigger	Low	CRT
2	Power supply on	Send info	1bit	1.017, trigger	Low	CRT
3	Send measurements	Request all measurements value	1bit	1.001,switch	Low	CW
4	Clear all data	Reset all calculation data	1bit	1.001,switch	Low	CW
5	Send calculations	Request all calculations value	1bit	1.001,switch	Low	CW
6	Bus reset	Request bus reset	1bit	1.001,switch	Low	CWU
7	Total working time	Send current total working time value	4byte	13.100,time lag,(s)	Low	CRT
8	Time from last startup	Send operating time from last startup	4byte	13.100,time lag,(s)	Low	CRT
9	The number of bus restart times	Send bus reset times value	2byte	7.001,pulses	Low	CRT
10	The number of device startup times	Send device startup times value	2byte	7.001,pulses	Low	CRT
11	Output voltage measured	Send voltage value measured	2byte	9.20,voltage,(mV)	Low	CRT
			4byte	14.027,electric potential,(V)	Low	CRT
12	Output voltage alarm	Send threshold status	1bit	1.005,alarm	Low	CRT
13	Output current measured	Send current value measured	2byte	7.012,current,(mA)	Low	CRT
			2byte	9.021,current,(mA)	Low	CRT
			4byte	14.019,electric current,(A)	Low	CRT
14	Output current alarm	Send threshold status	1bit	1.005,alarm	Low	CRT
15	Device temperature measured	Send temperature value measured	2byte	9.001,temperature,(°C)	Low	CRT
16	Device temperature alarm	Send threshold status	1bit	1.005,alarm	Low	CRT
17	Maximum output current during tracking period	Send maximum value captured	2byte	7.012,current,(mA)	Low	CRT
			2byte	9.021,current,(mA)	Low	CRT
			4byte	14.019,electric current,(A)	Low	CRT
18	Maximum device temperature during tracking period	Send maximum value captured	2byte	9.001,temperature,(°C)	Low	CRT
19	Busload measured	Send busload value calculated	1byte	5.004,percentage,(0~255%)	Low	CRT
20	Busload alarm	Send threshold status	1bit	1.005,alarm	Low	CRT
21	The number of overload times	Send times count value	2byte	7.001,pulses	Low	CRT
22	Overload duration	Send duration time value	4byte	13.100,time lag,(s)	Low	CRT
23	The number of short circuits times	Send times count value	2byte	7.001,pulses	Low	CRT
24	Time load detached	Send duration time value	4byte	13.100,time lag,(s)	Low	CRT
25	Alarm 1	Send threshold status	1bit	1.005,alarm	Low	CRT
26	Count 1	Send times count value	2byte	7.001,pulses	Low	CRT
27	Duration 1	Send duration time value	4byte	13.100,time lag,(s)	Low	CRT
28	Alarm 2	Send threshold status	1bit	1.005,alarm	Low	CRT
29	Count 2	Send times count value	2byte	7.001,pulses	Low	CRT
30	Duration 2	Send duration time value	4byte	13.100,time lag,(s)	Low	CRT
31	Alarm 3	Send threshold status	1bit	1.005,alarm	Low	CRT
32	Count 3	Send times count value	2byte	7.001,pulses	Low	CRT
33	Duration 3	Send duration time value	4byte	13.100,time lag,(s)	Low	CRT
34	Alarm 4	Send threshold status	1bit	1.005,alarm	Low	CRT
35	Count 4	Send times count value	2byte	7.001,pulses	Low	CRT
36	Duration 4	Send duration time value	4byte	13.100,time lag,(s)	Low	CRT

The priority of the particular communication objects as well as the flags can be adjusted. The flag control the function of the objects in the programming where C stands for communication, R for Read, W for write, T for transmit and U for update.

■ Typical application

◎ Application 1: Powering KNX Bus Only

KNX Bus

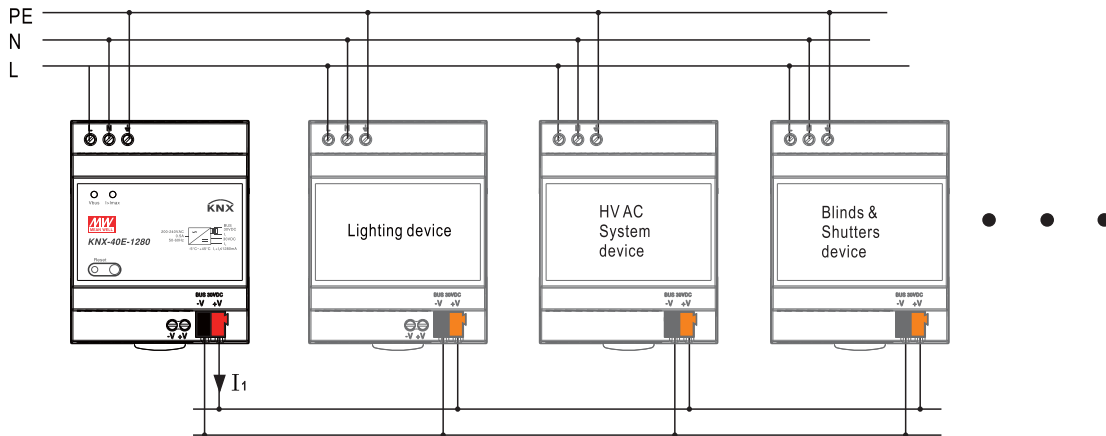

Bus wiring consideration:

1. the maximum number of bus devices connected is 256 for TP1-256 topology.
2. the maximum length of a line segment is 350 m, measured along the line between the power supply and the furthest device bus.
3. the maximum distance between two bus devices cannot exceed 700 m.
4. the maximum length of a bus line is 1000 m, keeping into account all segments.
5. It is possible to connect two KNX-40E-1280 in parallel with following conditions: Two chokes installed in one line with at least 200m apart.

◎ Application 2: Powering KNX Bus and KNX device

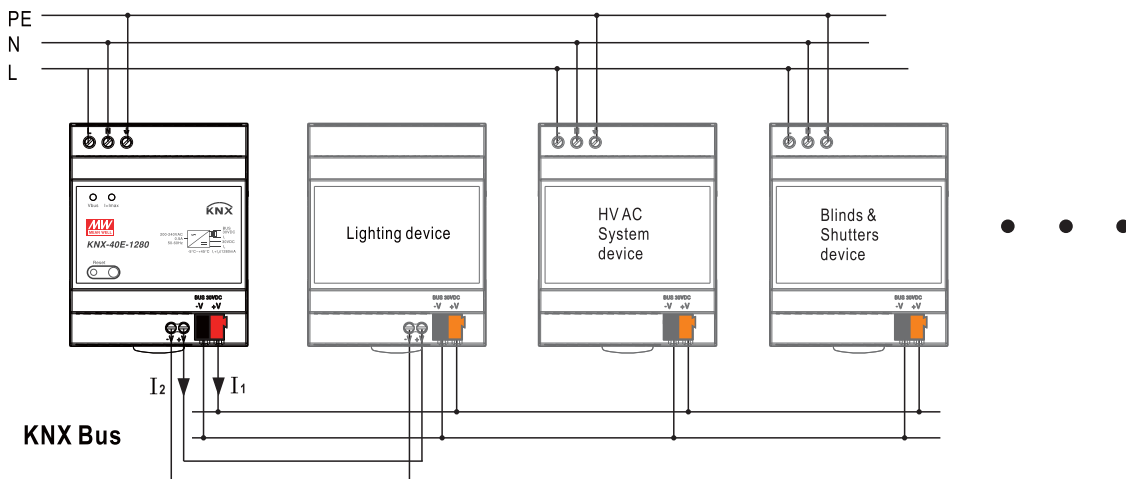

Note:

1. Use only ancillary output of KNX-40E-1280 to power the KNX device
2. The total current  $I_1 + I_2$  should be equal or less than 1280mA.  $I_1 + I_2 \leq 1280\text{mA}$
3. The above Bus wiring consideration is still applicable

■ Recommended Screwdriver, Wire and Torque Setting

1. Screwdriver (Width\*Thick): Slotted screwdriver 2.5\*0.4~3.5\*0.6
2. Wire: 0.5~4.0mm<sup>2</sup> solid core or 0.5~2.5mm<sup>2</sup> finely stranded
3. Torque: 0.8Nm

■ Installation Manual

Please refer to : <http://www.meanwell.com/manual.html>