

SECTION A-A

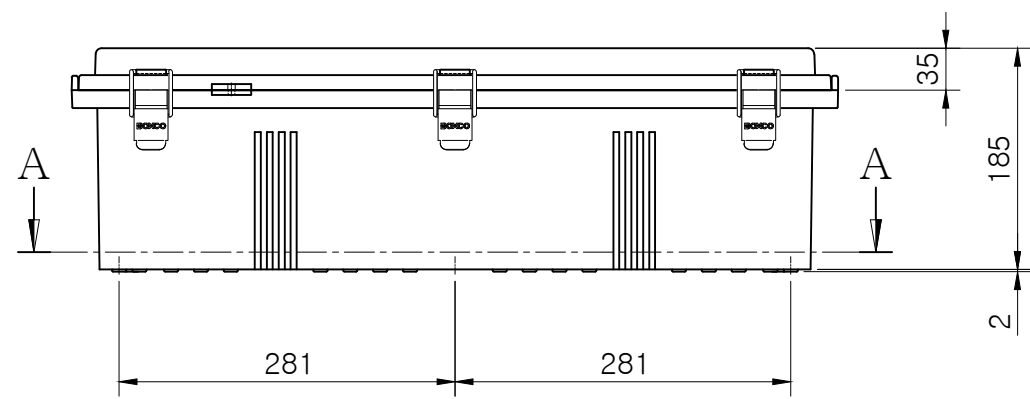

SECTION B-B

Note.

MODEL (모델)	BC-□□P-506018		D R (제 도)	JUNG,Y.J.	16.05.09	UNIT (단 위)	mm
ASSY (완성 규격)	530 * 630 * 185		C K (검 도)	PARK,Y.J.	16.05.09	SCALE (척 도)	1:6
DWG NO (도 번)	P-506018-03	MATERIAL (재 질)	A P (승 인)	KIM,D.S.	16.05.10	REV. (개 정)	0

