



ENCLOSURE CATALOGUE

BOXCO® Boxco enclosures are the products with quality recognized from all over the world

■ Features of plastic material of BOXCO

1. Ultraviolet Stabilizer is added to protect the enclosures for outdoor usage. Few colour changes will be noticed even after a long time of use.
2. Anti-static material is used to protect sensitive electronic instruments from static electricity.
3. It is made of high impact resistant material which is very strong against external impact and also prevents breakage during hole and press processing.
4. Special spec can be added besides standard specification. We can supply optimized products with the spec and material you choose.

■ Flammability of BOXCO material

ABS (Grey Color) : 94-HB(standard)or 94-V-O (optional for terminal block series)

ABS (Grayish blue Color) : 94-5VB or 94-V-O

PC / ABS : 94-5VA

PC (Transparent) : 94-HB(standard)or 94-V-O (optional for terminal block series)

PC (Grey) : 94-V-O

■ Materials of BOXCO plastic products

ABS : Acrylonitrile Butadiene Styrene

PC (Transparent) : Polycarbonate

PBT / PC : Polybutylene Terephthalate + Polycarbonate

Material can be changed for Quality improving

PC/ABS : Polycarbonate + Acrylonitrile Butadiene Styrene

PC (Grey) : Polycarbonate or Polycarbonate + Glass Fiber

■ Plastic materials by model

BC-AGP , AGH, AGS, AGM : Cover(ABS), Base(ABS)

BC-PGP , PGH, PGS, PGM : Cover(PC/ABS), Base(PC/ABS)

BC-CGP , CGH, CGS, CGM : Cover(PC), Base(PC)

BC-ATP , ATH, ATS, ATM : Cover(PC), Base(ABS)

BC-PTP , PTH, PTS, PTM : Cover(PC), Base(PC/ABS)

BC-CTP , CTH, CTS, CTM : Cover(PC), Base(PC)



The Control Box, Terminal Box, Switch Box, Joint Box, Cable Gland..... with BOXCO.

IP.IK BOXCO Ingress Protection Grade

IP 66/67, IK 07/08 protection plastic enclosure

IP 66/67, IK 09/10 protection aluminium enclosure

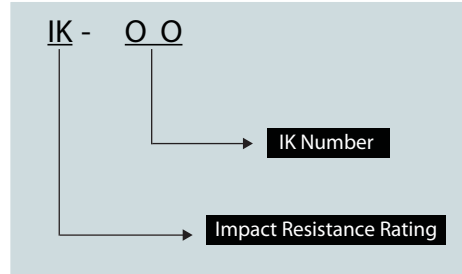
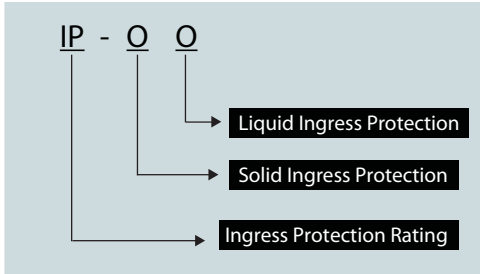

IEC (International Electrotechnical Commission) defines protection structure of electric instruments or protection boxes as follows :

1 FIRST NUMBER	PROTECTION AGAINST SOLID	2 SECOND NUMBER	PROTECTION AGAINST LIQUID	IK CODE	PROTECTION AGAINST MECHANICAL IMPACT
IP	TEST	IP	TEST	IK	TEST
0	No Protection	0	No Protection	0	No Protection
1	Protected against solid objects up to 50mm, e.g accidental touch by hands.	1	Protected against vertically falling drops of water e.g. condensation.	01 05	Impact { 1 joule
2	Protected against solid objects up to 12mm, e.g fingers.	2	Protected against direct sprays of water up to 15° from the vertical.	06	Impact = 1 joule
3	Protected against solid objects over 2.5mm (tools and wires).	3	Protected against direct sprays of water up to 60° from the vertical.	07	Impact = 2 joule
4	Protected against solid objects over 1mm (tools, wires and small wires).	4	Protected against water sprays from all directions ° limited ingress permitted.	08	Impact = 5 joule
5	Protected against dust limited ingress (no harmful deposit).	5	Protected against low pressure jets of water from all directions ° limited ingress.	09	Impact = 10 joule
6	Totally protected against dust	6	Protected against low pressure jets of water, e.g. for use on ship decks- limited ingress permitted.	10	Impact = 20 joule
		7	Protected against the effect of immersion between 15cm and 1m for 30 minutes.		
		8	Protected against long periods of immersion under pressure.		

P Series - Draw Latch

Main part of the draw latch are made of stainless steel so it is very strong



Bracket Mounting Point

By using brass insert in injection molding, it helps to fix the enclosure tightly onto other surfaces



P Series - Integrated Hinge

Hinge is made of plastic and is integrated with the enclosure. Bearing is made of stainless steel to increase the life span.



Mounting Plate Attachment Part

Internal mounting plate can be fixed tightly onto the brass inserted injection molding to handle heavy equipments installed inside the enclosure



P Series - Roof Function

Both ends of the P series are protruded to protect against penetration of water when using it outdoor and penetration of dust when opening/closing the cover



Pre-molded Mounting Screw Nuts

You can easily fix DIN RAIL or other equipment onto the pre-molded screw nuts



H Series - SUS Latch

It has double lock system and has been tested to prevent loosening during vibration



Plastic Mounting Plate

The plate is made from ABS materials and it is easy to drill holes and has excellent insulation property

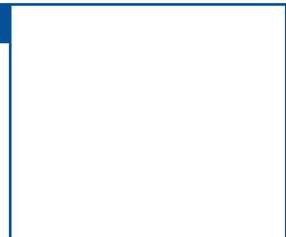

H Series - SUS Hinge

Available in different sizes to suit different size of enclosures



Steel Mounting Plate

Very strong steel mounting plate designed to handle heavy equipments installed inside the enclosure



S Series - Cover Bolt Mounting Point

Screw thread was made in injection molding to ensure maximum strength



Gasket

The gasket is injected by super precise CNC robot machine to produce excellent waterproof and dust-proof performance



M Series - Low Profile Cover Screw Type

It has low profile cover design for attachment of membrane keyboard



Knock-out Holes

Easy to knock-out holes available in Knock-out Boxes, Push Button Boxes and Terminal Block Boxes





The dimension of mounting plate is based on the plastic mounting and the dimension with a round bracket is steel mounting plate

DIMENSIONS (±1 mm)

	Division Size	W1	W2	W3	H1	H2	H3	H4	D1	D2	D3
	50 x 65 x 45	50	44	37	65	59	52	40	30	15	29.5
	50 x 65 x 55	65	59	47	95	89	77	65	40	15	39.5
	65 x 95 x 55	75	69	57	105	99	87	75	40	15	39.5
	75 x 105 x 55	80	74	62	80	94	62	50	45	15	43
	80 x 80 x 60	80	74	62	110	104	92	80	25	20	28
	80 x 110 x 45	80	74	62	110	104	92	80	50	20	53
	80 x 110 x 70	80	74	62	110	104	92	80	50	35	68
	80 x 110 x 85	80	74	62	130	124	112	100	50	20	53
	80 x 130 x 70	80	74	62	130	124	112	100	50	35	68
	80 x 130 x 85	80	74	62	180	174	162	150	50	20	53
	80 x 160 x 55	80	74	62	180	174	162	150	50	35	68
	80 x 160 x 85	80	74	62	250	244	232	220	50	20	52
	80 x 180 x 70	80	74	62	250	244	232	220	50	35	67
	80 x 180 x 85	100	94	82	100	94	82	60	55	20	58
	80 x 250 x 70	100	94	82	100	94	82	60	80	20	83
	80 x 250 x 85	100	94	82	185	179	167	139	55	15	53
	100 x 100 x 75	100	94	82	200	194	182	158	55	15	53
	100 x 100 x 100	100	94	82	230	224	212	184	55	15	53
	100 x 185 x 70	125	119	105	125	119	105	70	55	20	58
	100 x 200 x 70	125	119	105	125	119	105	70	80	20	83
	100 x 230 x 70	125	121	109	175	169	157	140	50	25	58
	125 x 125 x 75	125	121	109	175	169	157	140	50	50	83
	125 x 175 x 75	140	137	122	173	167	152	130	75	20	77
	125 x 175 x 100	140	137	122	230	224	212	190	75	20	77
	140 x 170 x 95	150	144	110	150	144	132	110	55	20	58
	140 x 230 x 95	150	144	110	150	144	132	110	80	20	83
	150 x 150 x 75	150	142	132	200	192	182	160	55	20	58
	150 x 150 x 100	150	142	132	200	192	182	160	80	20	83
	150 x 200 x 75	150	142	132	200	192	182	160	110	20	111
	150 x 200 x 100	150	142	132	200	192	182	160	110	50	149
	150 x 200 x 130	150	142	132	250	242	232	210	80	20	83
	150 x 200 x 160	150	142	132	250	242	232	210	80	50	113
	150 x 250 x 100	160	154	110	160	154	142	110	55	15	53
	150 x 250 x 130	200	193	182	200	193	182	120	80	20	82
	160 x 160 x 70	200	193	182	200	193	182	120	110	20	111
	200 x 200 x 100	200	193	182	200	193	182	120	110	50	141
	200 x 200 x 130										
	200 x 200 x 160										
Water proof	IP 66/67										
Impact proof	IK 07/08										
Temperature	ABS : -40~+85 PC: -40~+120										
Flammability	ABS : 94-HB PC : 94-HB, 94-V-0~5VA										

PRODUCT CHARACTERISTICS

1. The screw thread channel of the enclosure base is formed by injection molding. It not only provides sufficient strength but also prevents damage when tightening the bolts.
2. The thickness of the enclosure is reinforced, providing high reliability and durability.



MODEL AND SIZE

Size (cover included)	Product Model				Plate Model		Plate Size	
	ABS		PC		Steel Mounting Plate 1.6mm	Plastic Mounting Plate 3-4.5 mm	M1	M2
	Grey Cover	Transparent Cover	Grey Cover	Transparent Cover				
50 x 65 x 45	BC-AGS-050604	BC-ATS-050604	BC-CGS-050604	BC-CTS-050604	0506 S		(52)	(38)
50 x 65 x 55	BC-AGS-050605	BC-ATS-050605	BC-CGS-050605	BC-CTS-050605	0506 S		(52)	(38)
65 x 95 x 55	BC-AGS-060905	BC-ATS-060905	BC-CGS-060905	BC-CTS-060905	0609 S		(50)	(80)
75 x 105 x 55	BC-AGS-071005	BC-ATS-071005	BC-CGS-071005	BC-CTS-071005	0710 S		(60)	(90)
80 x 80 x 60	BC-AGS-080806	BC-ATS-080806	BC-CGS-080806	BC-CTS-080806	0808 S		(65)	(65)
80 x 110 x 45	BC-AGS-081104	BC-ATS-081104	BC-CGS-081104	BC-CTS-081104	0811 S	0811 P	65	95
80 x 110 x 70	BC-AGS-081107	BC-ATS-081107	BC-CGS-081107	BC-CTS-081107	0811 S	0811 P	65	95
80 x 110 x 85	BC-AGS-081108	BC-ATS-081108	BC-CGS-081108	BC-CTS-081108	0811 S	0811 P	65	95
80 x 130 x 70	BC-AGS-081307	BC-ATS-081307	BC-CGS-081307	BC-CTS-081307	0813 S	0813 P	65	115
80 x 130 x 85	BC-AGS-081308	BC-ATS-081308	BC-CGS-081308	BC-CTS-081308	0813 S	0813 P	65	115
80 x 160 x 55	BC-AGS-081605	BC-ATS-081605	BC-CGS-081605	BC-CTS-081605	0816 S	0816 P	65	152
80 x 160 x 85	BC-AGS-081608	BC-ATS-081608	BC-CGS-081608	BC-CTS-081608	0816 S	0816 P	65	152
80 x 180 x 70	BC-AGS-081807	BC-ATS-081807	BC-CGS-081807	BC-CTS-081807	0818 S	0818 P	65	165
80 x 180 x 85	BC-AGS-081808	BC-ATS-081808	BC-CGS-081808	BC-CTS-081808	0818 S	0818 P	65	165
80 x 250 x 70	BC-AGS-082507	BC-ATS-082507	BC-CGS-082507	BC-CTS-082507	0825 S	0825 P	65	235
80 x 250 x 85	BC-AGS-082508	BC-ATS-082508	BC-CGS-082508	BC-CTS-082508	0825 S	0825 P	65	235
100x100x75	BC-AGS-101007	BC-ATS-101007	BC-CGS-101007	BC-CTS-101007	1010 S	1010 P	88	89
100x100x100	BC-AGS-101010	BC-ATS-101010	BC-CGS-101010	BC-CTS-101010	1010 S	1010 P	88	89
100x185x70	BC-AGS-101807	BC-ATS-101807	BC-CGS-101807	BC-CTS-101807	1018 S	1018 P	(88)	(174)
100x200x70	BC-AGS-102007	BC-ATS-102007	BC-CGS-102007	BC-CTS-102007	1020 S		(88)	(189)
100x230x70	BC-AGS-102307	BC-ATS-102307	BC-CGS-102307	BC-CTS-102307	1023 S		(88)	(219)
125x125x75	BC-AGS-121207	BC-ATS-121207	BC-CGS-121207	BC-CTS-121207	1212 S	1212 P	101	102
125x125x100	BC-AGS-121210	BC-ATS-121210	BC-CGS-121210	BC-CTS-121210	1212 S	1212 P	101	102
125x175x75	BC-AGS-121707	BC-ATS-121707	BC-CGS-121707	BC-CTS-121707	1217 S	1217 P	101	156
125x175x100	BC-AGS-121710	BC-ATS-121710	BC-CGS-121710	BC-CTS-121710	1217 S	1217 P	101	156
140x170x95	BC-AGS-141709	BC-ATS-141709	BC-CGS-141709	BC-CTS-141709	1417 S	1417 P	122	154
140x230x95	BC-AGS-142309	BC-ATS-142309	BC-CGS-142309	BC-CTS-142309	1423 S	1423 P	122	211
150x150x75	BC-AGS-151507	BC-ATS-151507	BC-CGS-151507	BC-CTS-151507	1515 S	1515 P	134	134
150x150x100	BC-AGS-151510	BC-ATS-151510	BC-CGS-151510	BC-CTS-151510	1515 S	1515 P	134	134
150x200x75	BC-AGS-152007	BC-ATS-152007	BC-CGS-152007	BC-CTS-152007	1520 S	1520 P	136	186
150x200x100	BC-AGS-152010	BC-ATS-152010	BC-CGS-152010	BC-CTS-152010	1520 S	1520 P	136	186
150x200x130	BC-AGS-152013	BC-ATS-152013	BC-CGS-152013	BC-CTS-152013	1520 S	1520 P	129	179
150x200x160	BC-AGS-152016	BC-ATS-152016	BC-CGS-152016	BC-CTS-152016	1520 S	1520 P	129	179
150x250x100	BC-AGS-152510	BC-ATS-152510	BC-CGS-152510	BC-CTS-152510	1525 S	1525 P	136	235
150x250x130	BC-AGS-152513	BC-ATS-152513	BC-CGS-152513	BC-CTS-152513	1525 S	1525 P	136	235
160x160x70	BC-AGS-161607	BC-ATS-161607	BC-CGS-161607	BC-CTS-161607	1616 S		134	134
200x200x100	BC-AGS-202010	BC-ATS-202010	BC-CGS-202010	BC-CTS-202010	2020 S	2020 P	187	187
200x200x130	BC-AGS-202013	BC-ATS-202013	BC-CGS-202013	BC-CTS-202013	2020 S	2020 P	187	187
200x200x160	BC-AGS-202016	BC-ATS-202016	BC-CGS-202016	BC-CTS-202016	2020 S	2020 P	187	187

ACCESSORIES

Steel mounting plate (Zinc plating)



Plastic mounting plate (ABS)



Cover bolt (optional) (CB20-)



Cover bolt (standard provide) (CB20)



Cover bolt (standard provide) (CB35)



Cover bolt (standard provide) (CB50)



Wall mounting bracket (B40)



Plastic bracket (PB 25,20)



The dimension of mounting plate is based on the plastic mounting plate and the dimension with a round bracket is steel mounting plate

DIMENSIONS (±1 mm)

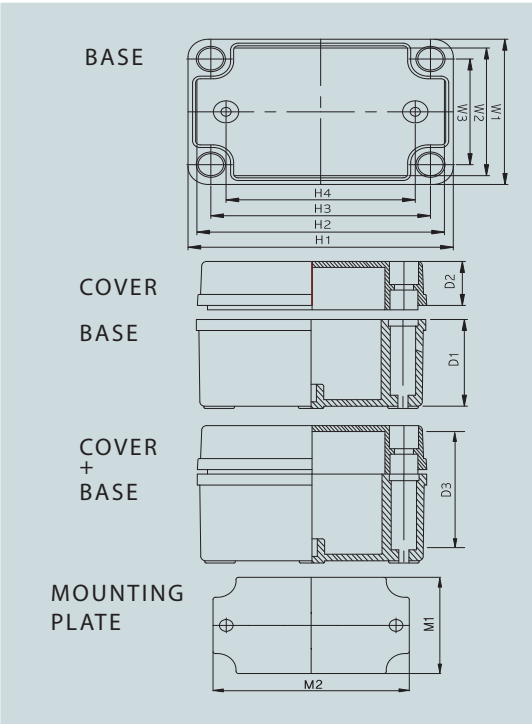

Size	Division								D1	D2	D3
	W1	W2	W3	W4	H1	H2	H3	H4			
190 x 190 x 130	190	170	165	120	190	170	165	120	98	30	112
190 x 280 x 130	190	170	165	120	280	266	255	210	98	30	112
190 x 280 x 180	190	170	165	120	280	266	255	210	150	30	159
190 x 380 x 130	190	170	165	120	380	359	355	310	98	30	109
190 x 380 x 180	190	170	165	120	380	360	355	310	150	30	159
280 x 280 x 130	280	266	255	210	280	266	255	210	98	30	112
280 x 340 x 130	280	259	254.7	210	340	319	315	270	100	30	111
280 x 380 x 130	280	266	255	210	380	359	355	310	98	30	111
280 x 380 x 180	280	266	255	210	380	359	355	310	150	30	161.5
280 x 560 x 130	280	296	255	210	560	535	505	490	100	30	120
330 x 430 x 180	330				430				150	30	
380 x 560 x 180	380	366	355	310	560	535	505	490	150	30	160

Water proof	IP 66/67
Impact proof	IK 07/08
Temperature	ABS :-40~+85 PC:-40~+120
Flammability	ABS :94-HB PC : 94-HB, 94-V-0~5VA

PRODUCT CHARACTERISTICS

1. The screw thread channel of the enclosure base is formed by injection molding. It not only provides sufficient strength but also prevents damage when tightening the bolts.
2. The enclosure is designed as 4 side sliding type, providing resistance against impact and vibration.



MODEL AND SIZE

Size (cover included)	Product Model				Plate Model		Plate Size	
	ABS		PC		Steel Mounting Plate 1.6mm	Plastic Mounting Plate 3-4.5 mm	M1	M2
Width x Length x Height (mm)	Grey Cover	Transparent Cover	Grey Cover	Transparent Cover				
190 x 190 x 130	BC-AGS-191913	BC-ATS-191913	BC-CGS-191913	BC-CTS-191913	1919 S	1919 P	159	159
190 x 280 x 130	BC-AGS-192813	BC-ATS-192813	BC-CGS-192813	BC-CTS-192813	1928 S	1928 P	159	248
190 x 280 x 180	BC-AGS-192818	BC-ATS-192818	BC-CGS-192818	BC-CTS-192818	1928 S	1928 P	159	248
190 x 380 x 130	BC-AGS-193813	BC-ATS-193813	BC-CGS-193813	BC-CTS-193813	1938 S	1938 P	159	348
190 x 380 x 180	BC-AGS-193818	BC-ATS-193818	BC-CGS-193818	BC-CTS-193818	1938 S	1938 P	159	348
280 x 280 x 130	BC-AGS-282813	BC-ATS-282813	BC-CGS-282813	BC-CTS-282813	2828 S	2828 P	248	248
280 x 340 x 130	BC-AGS-283413	BC-ATS-283413	BC-CGS-283413	BC-CTS-283413	2834 S	2834 P	248	308
280 x 380 x 130	BC-AGS-283813	BC-ATS-283813	BC-CGS-283813	BC-CTS-283813	2838 S	2838 P	248	348
280 x 380 x 180	BC-AGS-283818	BC-ATS-283818	BC-CGS-283818	BC-CTS-283818	2838 S	2838 P	248	348
280 x 560 x 130	BC-AGS-285613	BC-ATS-285613	BC-CGS-285613	BC-CTS-285613	2856 S		(232)	(535)
330 x 430 x 180	BC-AGS-334318	BC-ATS-334318	BC-CGS-334318	BC-CTS-334318	3343 S	3343 P	(295)	(395)
380 x 560 x 180	BC-AGS-385618	BC-ATS-385618	BC-CGS-385618	BC-CTS-385618	3856 S		(345)	(535)

ACCESSORIES

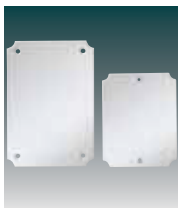

Steel mounting plate
(Zinc plating)



Plastic mounting plate (ABS)



Cover bolt (standard provide) (CB28-)



Cover bolt (optional) (CB28+)



Wall mounting bracket (B50)

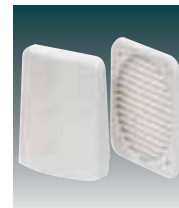

Vent (V60, V80)



Plastic bracket (PB 25)





The dimension of mounting plate is based on the plastic mounting plate and the dimension with a round bracket is steel mounting plate

DIMENSIONS (±1 mm)

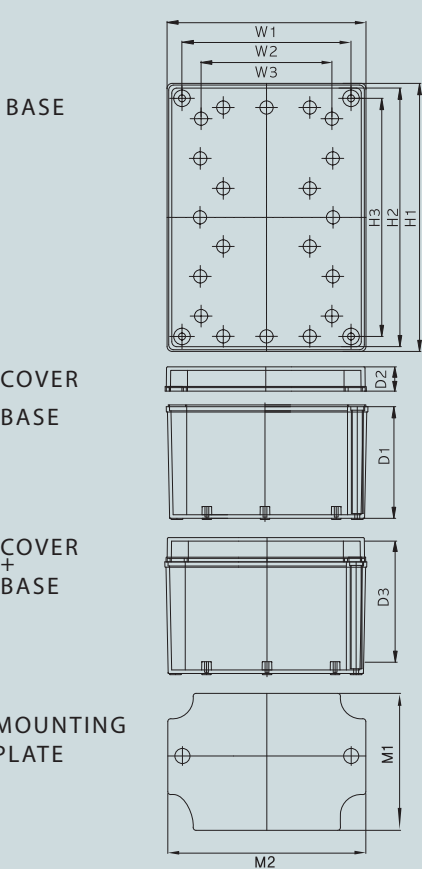

Division Size	W1	W2	W3	H1	H2	H3	D1	D2	D3
80 x 130 x 35	80	62	40	130	112	90	25	10	21.5
80 x 130 x 60	80	62	40	130	112	90	50	10	46.5
80 x 130 x 75	80	62	40	130	112	90	65	10	61.5
80 x 130 x 85	80	62	40	130	112	90	50	35	71.5
80 x 130 x 100	80	62	40	130	112	90	90	10	87.5
80 x 130 x 125	80	112	40	130	112	90	90	35	111.5
130 x 130 x 35	130	112	90	130	112	90	25	10	21.5
130 x 130 x 60	130	112	90	130	112	90	50	10	46.5
130 x 180 x 35	130	112	90	180	162	140	25	10	21.5
130 x 180 x 60	130	132	90	180	162	140	50	10	46.5
150 x 180 x 60	150	162	110.5	180	162	140	50	10	45.5
180 x 180 x 60	180	162	140	180	162	140	50	10	45.5
180 x 180 x 75	180	162	140	180	162	140	65	10	59.5
180 x 180 x 100	180	162	140	180	162	140	90	10	84.5
180 x 180 x 125	180	162	140	180	162	140	115	10	109.5
180 x 255 x 75	180	162	140	255	244	201.5	60	15	59.5
180 x 255 x 100	180	162	140	255	94	201.5	85	15	84.5
180 x 255 x 125	180	162	140	255	94	201.5	110	15	109.5

Water proof	IP 66/67
Impact proof	IK 07/08
Temperature	ABS : -40~+85 PC: -40~+120
Flammability	ABS : 94-HB PC : 94-HB, 94-V-0~5VA

PRODUCT CHARACTERISTICS

1. The centre surface of the cover is designed to be slightly lower which is suitable for installation of membrane type keyboard.
2. The screw thread channel of the enclosure base is formed by injection molding. It not only provides sufficient strength but also prevents damage when tightening the bolts.
3. The cover is thin and base is thick which provides a refined and stable appearance.



MODEL AND SIZE

Size (cover included)	Product Model				Plate Model		Plate Size	
Width x Length x Height (mm)	ABS		PC		Steel Mounting Plate 1.6mm	Plastic Mounting Plate 3~4.5 mm	M1	M2
	Grey Cover	Transparent Cover	Grey Cover	Transparent Cover				
80 x 130 x 35	BC-AGM-081303	BC-ATM-081303	BC-CGM-081303	BC-CTM-081303	0813 S	0813 P	(49)	(98)
80 x 130 x 60	BC-AGM-081306	BC-ATM-081306	BC-CGM-081306	BC-CTM-081306	0813 S	0813 P	(49)	(98)
80 x 130 x 75	BC-AGM-081307	BC-ATM-081307	BC-CGM-081307	BC-CTM-081307	0813 S	0813 P	(49)	(98)
80 x 130 x 85	BC-AGM-081308	BC-ATM-081308	BC-CGM-081308	BC-CTM-081308	0813 S	0813 P	(49)	(98)
80 x 130 x 100	BC-AGM-081310	BC-ATM-081310	BC-CGM-081310	BC-CTM-081310	0813 S	0813 P	(49)	(98)
80 x 130 x 125	BC-AGM-081312	BC-ATM-081312	BC-CGM-081312	BC-CTM-081312	0813 S	0813 P	(49)	(98)
130 x 130 x 35	BC-AGM-131303	BC-ATM-131303	BC-CGM-131303	BC-CTM-131303	1313 S	1313 P	(98)	(98)
130 x 130 x 60	BC-AGM-131306	BC-ATM-131306	BC-CGM-131306	BC-CTM-131306	1313 S	1313 S	(98)	(98)
130 x 180 x 35	BC-AGM-131803	BC-ATM-131803	BC-CGM-131803	BC-CTM-131803	1318 S	1318 P	113	161
130 x 180 x 60	BC-AGM-131806	BC-ATM-131806	BC-CGM-131806	BC-CTM-131806	1318 S	1318 P	113	161
150 x 180 x 60	BC-AGM-151806	BC-ATM-151806	BC-CGM-151806	BC-CTM-151806	1518 S		(123)	(161)
180 x 180 x 60	BC-AGM-181806	BC-ATM-181806	BC-CGM-181806	BC-CTM-181806	1818 S	1818 P	(148)	(148)
180 x 180 x 65	BC-AGM-181807	BC-ATM-181807	BC-CGM-181807	BC-CTM-181807	1818 S	1818 P	(148)	(148)
180 x 180 x 100	BC-AGM-181810	BC-ATM-181810	BC-CGM-181810	BC-CTM-181810	1818 S	1818 P	(148)	(148)
180 x 180 x 125	BC-AGM-181812	BC-ATM-181812	BC-CGM-181812	BC-CTM-181812	1818 S	1818 P	(148)	(148)
180 x 255 x 75	BC-AGM-182507	BC-ATM-182507	BC-CGM-182507	BC-CTM-182507	1825 S		(148)	(223)
180 x 255 x 100	BC-AGM-182510	BC-ATM-182510	BC-CGM-182510	BC-CTM-182510	1825 S		(148)	(223)
180 x 255 x 125	BC-AGM-182512	BC-ATM-182512	BC-CGM-182512	BC-CTM-182512	1825 S		(148)	(223)

ACCESSORIES



Steel mounting plate
(Zinc plating)

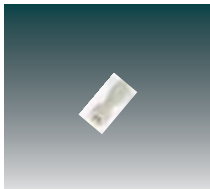

Cover bolt (standard
provide) (CB10)

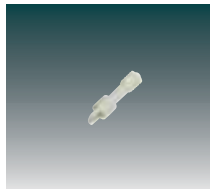

Cover bolt (optional
provide) (CB20-)



Cover bolt (standard
provide) (CB20)



Wall mounting bracket
(B40)



Plastic bracket (PB20)





DIMENSION (±1 mm)

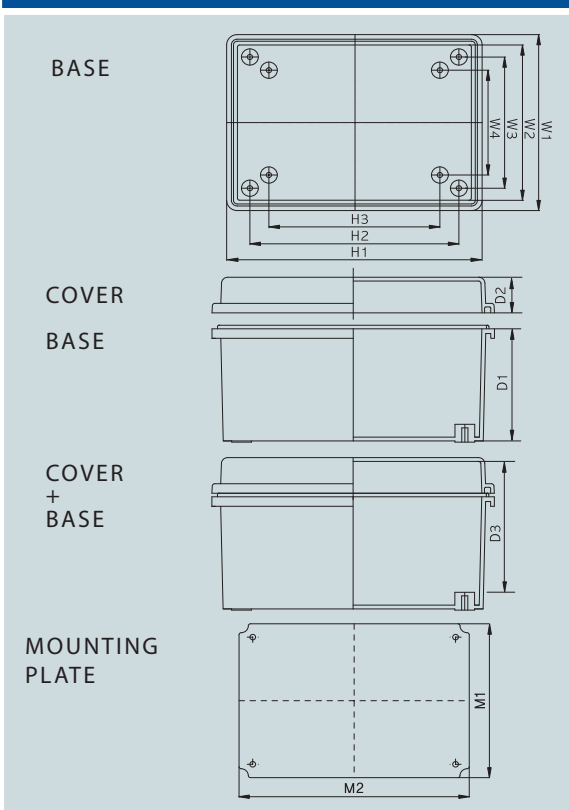

Size	Division				H1	H2	H3	D1	D2	D3
	W1	W2	W3	W4						
90 x 120 x 70	90	77.5	50	0	128.4	80	69	50	20	51.5
90 x 120 x 85	90	77.5	50	0	128.4	80	69	65	20	66.5
100 x 150 x 70	100	87.5	60	0	153.4	110	99	50	20	51.5
100 x 150 x 85	100	87.5	60	0	158.4	110	99	65	20	66.5
110 x 210 x 75	110	87.7	70	0	218.4	170	158	55	20	56.5
110 x 210 x 100	110	87.7	70	0	218.4	170	158	80	20	81.5
110 x 260 x 75	110	87.7	70	0	268.4	220	208	55	20	56.5
110 x 260 x 100	110	87.7	70	0	268.4	220	208	80	20	81.5
135 x 155 x 85	135	115	105	0	150	119.3	110	65	20	67.5
135 x 185 x 85	135	108	95	0	193.4	145	140	65	20	67.5
135 x 185 x 100	135	108	95	0	193.4	145	140	80	20	82.5
150 x 150 x 90	150	130	120	0	150	120	110	70	20	71.5
150 x 150 x 120	150	130	120	0	150	120	110	100	20	101.5
160 x 210 x 100	160	137	120	0	218.4	170	160	75	25	81.5
160 x 210 x 130	160	137	120	0	218.4	170	160	105	25	111.5
160 x 260 x 100	160	144.6	120	0	268.4	220	210	75	25	85.5
160 x 260 x 130	160	144.6	120	0	268.4	220	210	105	25	111.5
170 x 220 x 110	170	149.6	132	0	228.4	182	160	80	30	93
170 x 270 x 110	170	149.6	132	0	278.4	232	210	80	30	93
190 x 280 x 100	190	173.5	148	120	228.4	238	210	70	30	108.5
190 x 280 x 140	190	173.5	148	120	228.4	238	210	110	30	128.5
200 x 300 x 130	200	181.8	152	129	308.4	252	226	100	30	108
200 x 300 x 150	200	181.8	152	129	308.4	252	226	120	30	128.5
200 x 300 x 180	200	181.8	152	129	308.4	252	226	150	30	158.5
210 x 210 x 100	210	192.3	170	120	218.4	170	150	75	25	81.5
210 x 210 x 130	210	192.3	170	120	218.4	170	150	105	25	111.5
250 x 350 x 150	250	231.8	202	180	358.4	302	271	120	30	130
250 x 350 x 180	250	231.8	202	180	358.4	302	271	150	30	160
280 x 280 x 130	280	264.1	238	210	288.4	238	210	100	30	108
280 x 380 x 130	280	264.1	238	210	388.4	338	310	100	30	108
300 x 300 x 150	300	283.3	252	230	308.4	252	219	120	30	131.5
300 x 300 x 180	300	283.3	252	230	308.4	252	219	150	30	161.5
300 x 400 x 120	300	275.5	252	228	408.4	352	325	90	30	98.5
300 x 400 x 150	300	275.5	252	228	408.4	352	325	120	30	128.5
300 x 400 x 180	300	275.5	252	228	408.4	352	325	150	30	158.5
350 x 350 x 150	350	333.8	302	270	358.4	302	270	120	30	132
350 x 350 x 180	350	333.8	302	270	358.4	302	270	150	30	162
350 x 450 x 120	350	325.4	300	274	457.4	400	365	90	30	98
350 x 450 x 150	350	325.4	300	274	457.4	400	365	130	30	138
350 x 450 x 180	350	325.4	300	274	457.4	400	365	170	30	178
400 x 500 x 160	400	370.5	352	328	511.4	452	428	130	35	137
400 x 500 x 200	400	370.5	352	328	511.4	452	428	170	35	178
400 x 600 x 180	401	370.5	352	328	611.4	552	525	150	35	158
400 x 600 x 230	401	370.5	352	328	611.4	552	525	200	35	208
530 x 630 x 185	530	487.4	462	426	641.4	562	526	150	35	163
530 x 630 x 255	530	487.4	462	426	641.4	562	526	220	35	233
530 x 730 x 185	530	487.4	462	426	741.4	662	626	150	35	163
530 x 730 x 255	530	487.4	462	426	741.4	662	626	220	35	233
630 x 830 x 185	630	581.9	562	526	841.4	762	726	150	35	163
630 x 830 x 285	630	581.9	562	526	841.4	762	726	220	35	253

Water proof	IP 66/67
Impact proof	IK 07/08
Temperature	ABS : -40~+85 PC: -40~+120
Flammability	ABS : 94-HB PC : 94-HB, 94-V-0~5VA

PRODUCT CHARACTERISTICS

1. A roof is extended from the top and bottom sides of the enclosure base. This design prevents rain and dust from penetrating.
2. Enclosure cover and base can be easily separated. This allows the use to attach or detach them easily for processing and printing.
3. Hinge is inserted to the product. Hinge connection pins and critical parts of draw latch are made of stainless steel which is very strong and resistant against corrosion and rust.



MODEL AND SIZE

Size (cover included)	Product Model				Plate Model		Plate Size	
Width x Length x Height (mm)	ABS		PC		Steel Mounting Plate 1.6mm	Plastic Mounting Plate 3~4.5 mm	M1	M2
	Grey Cover	Transparent Cover	Grey Cover	Transparent Cover				
90 x 120 x 70	BC-AGP-091207	BC-ATP-091207	BC-CGP-091207	BC-CTP-091207	0912 S	0912 P	65	95
90 x 120 x 85	BC-AGP-091208	BC-ATP-091208	BC-CGP-091208	BC-CTP-091208	0912 S	0912 P	65	95
100 x 150 x 70	BC-AGP-101507	BC-ATP-101507	BC-CGP-101507	BC-CTP-101507	1015 S	1015 P	65	115
100 x 150 x 85	BC-AGP-101508	BC-ATP-101508	BC-CGP-101508	BC-CTP-101508	1015 S	1015 P	65	115
110 x 210 x 75	BC-AGP-112107	BC-ATP-112107	BC-CGP-112107	BC-CTP-112107	1121 S	1121 P	88	189
110 x 210 x 100	BC-AGP-112110	BC-ATP-112110	BC-CGP-112110	BC-CTP-112110	1121 S	1121 P	88	189
110 x 260 x 75	BC-AGP-112607	BC-ATP-112607	BC-CGP-112607	BC-CTP-112607	1126 S	1126 P	85	232
110 x 260 x 100	BC-AGP-112610	BC-ATP-112610	BC-CGP-112610	BC-CTP-112610	1126 S	1126 P	85	232
135 x 155 x 85	BC-AGP-131508	BC-ATP-131508	BC-CGP-131508	BC-CTP-131508	1315 S	1315 P	101	126
135 x 185 x 85	BC-AGP-131808	BC-ATP-131808	BC-CGP-131808	BC-CTP-131808	1318 S	1318 P	113	161
135 x 185 x 100	BC-AGP-131810	BC-ATP-131810	BC-CGP-131810	BC-CTP-131810	1318 S	1318 P	113	161
150 x 150 x 90	BC-AGP-151509	BC-ATP-151509	BC-CGP-151509	BC-CTP-151509	1515 S	1515 P	123	123
150 x 150 x 120	BC-AGP-151512	BC-ATP-151512	BC-CGP-151512	BC-CTP-151512	1515 S	1515 P	123	123
160 x 210 x 100	BC-AGP-162110	BC-ATP-162110	BC-CGP-162110	BC-CTP-162110	1621 S	1621 P	129	179
160 x 210 x 130	BC-AGP-162113	BC-ATP-162113	BC-CGP-162113	BC-CTP-162113	1621 S	1621 P	129	179
160 x 260 x 100	BC-AGP-162610	BC-ATP-162610	BC-CGP-162610	BC-CTP-162610	1626 S	1626 P	129	224
160 x 260 x 130	BC-AGP-162613	BC-ATP-162613	BC-CGP-162613	BC-CTP-162613	1626 S	1626 P	129	224
170 x 220 x 110	BC-AGP-172211	BC-ATP-172211	BC-CGP-172211	BC-CTP-172211	1722 S	1722 P	129	179
170 x 270 x 110	BC-AGP-172711	BC-ATP-172711	BC-CGP-172711	BC-CTP-172711	1727 S	1727 P	129	224
190 x 280 x 100	BC-AGP-192810	BC-ATP-192810	BC-CGP-192810	BC-CTP-192810	1928 S	1928 P	159	248
190 x 280 x 140	BC-AGP-192814	BC-ATP-192814	BC-CGP-192814	BC-CTP-192814	1928 S	1928 P	159	248
200 x 300 x 130	BC-AGP-203013	BC-ATP-203013	BC-CGP-203013	BC-CTP-203013	2030 S	2030 P	166	266
200 x 300 x 150	BC-AGP-203015	BC-ATP-203015	BC-CGP-203015	BC-CTP-203015	2030 S	2030 P	166	266
200 x 300 x 180	BC-AGP-203018	BC-ATP-203018	BC-CGP-203018	BC-CTP-203018	2030 S	2030 P	166	266
210 x 210 x 100	BC-AGP-212110	BC-ATP-212110	BC-CGP-212110	BC-CTP-212110	2121 S	2121 P	179	179
210 x 210 x 130	BC-AGP-212113	BC-ATP-212113	BC-CGP-212113	BC-CTP-212113	2121 S	2121 P	179	179
250 x 350 x 150	BC-AGP-253515	BC-ATP-253515	BC-CGP-253515	BC-CTP-253515	2535 S	2535 P	216	316
250 x 350 x 180	BC-AGP-253518	BC-ATP-253518	BC-CGP-253518	BC-CTP-253518	2535 S	2535 P	216	316
280 x 280 x 130	BC-AGP-282813	BC-ATP-282813	BC-CGP-282813	BC-CTP-282813	2828 S	2828 P	248	248
280 x 380 x 130	BC-AGP-283813	BC-ATP-283813	BC-CGP-283813	BC-CTP-283813	2838 S	2838 P	248	348
300 x 300 x 150	BC-AGP-303015	BC-ATP-303015	BC-CGP-303015	BC-CTP-303015	3030 S	3030 P	262	262
300 x 300 x 180	BC-AGP-303018	BC-ATP-303018	BC-CGP-303018	BC-CTP-303018	3030 S	3030 P	262	262
300 x 400 x 120	BC-AGP-304012	BC-ATP-304012	BC-CGP-304012	BC-CTP-304012	3040 S	3040 P	265	365
300 x 400 x 150	BC-AGP-304015	BC-ATP-304015	BC-CGP-304015	BC-CTP-304015	3040 S	3040 P	265	365
300 x 400 x 180	BC-AGP-304018	BC-ATP-304018	BC-CGP-304018	BC-CTP-304018	3040 S	3040 P	265	365
350 x 350 x 150	BC-AGP-353515	BC-ATP-353515	BC-CGP-353515	BC-CTP-353515	3535 S	3535 P	320	320
350 x 350 x 180	BC-AGP-353518	BC-ATP-353518	BC-CGP-353518	BC-CTP-353518	3535 S	3535 P	320	320
350 x 450 x 120	BC-AGP-354512	BC-ATP-354512	BC-CGP-354512	BC-CTP-354512	3545 S	3545 P	306	407
350 x 450 x 160	BC-AGP-354516	BC-ATP-354516	BC-CGP-354516	BC-CTP-354516	3545 S	3545 P	306	407
350 x 450 x 200	BC-AGP-354520	BC-ATP-354520	BC-CGP-354520	BC-CTP-354520	3545 S	3545 P	306	407
400 x 500 x 160	BC-AGP-405016	BC-ATP-405016	BC-CGP-405016	BC-CTP-405016	4050 S	4050 P	358	458
400 x 500 x 200	BC-AGP-405020	BC-ATP-405020	BC-CGP-405020	BC-CTP-405020	4050 S	4050 P	358	458
400 x 600 x 180	BC-AGP-406018	BC-ATP-406018	BC-CGP-406018	BC-CTP-406018	4060 S	4060 P	358	558
400 x 600 x 230	BC-AGP-406023	BC-ATP-406023	BC-CGP-406023	BC-CTP-406023	4060 S	4060 P	358	558
530 x 630 x 185	BC-AGP-506018	BC-ATP-506018	BC-CGP-506018	BC-CTP-506018	5060 S	5060 P	450	555
530 x 630 x 255	BC-AGP-506025	BC-ATP-506025	BC-CGP-506025	BC-CTP-506025	5060 S	5060 P	450	555
530 x 730 x 185	BC-AGP-507018	BC-ATP-507018	BC-CGP-507018	BC-CTP-507018	5070 S	5070 P	450	655
530 x 730 x 255	BC-AGP-507025	BC-ATP-507025	BC-CGP-507025	BC-CTP-507025	5070 S	5070 P	450	655
630 x 830 x 185	BC-AGP-608018	BC-ATP-608018	BC-CGP-608018	BC-CTP-608018	6080 S		550	755
630 x 830 x 255	BC-AGP-608028	BC-ATP-608028	BC-CGP-608028	BC-CTP-608028	6080 S		550	755

ACCESSORIES



Steel mounting plate (Zinc plating)



Plastic mounting plate (ABS)



Key ring (K40)



Locker (SK)



Plastic locker (PK)



(PSK)

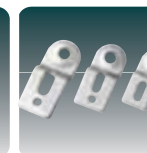

Wall mounting bracket (B40,B50,B60)

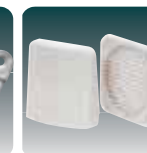

Vent (V60,V80)



Plastic bracket (PB 20, 25)



The dimension of mounting plate is based on the plastic mounting plate and the dimension with a round bracket is steel mounting plate

DIMENSIONS (± 1 mm)

	Division	Size											
		W1	W2	W3	W4	H1	H2	H3	H4	D1	D2	D3	
BASE	80 x 110 x 70	80	74	62	0	110	104	92	80	50	20	53	
	110 x 80 x 70	110	104	92	80	80	74	62	0	50	20	53	
	80 x 110 x 85	80	74	62	0	110	104	92	80	50	35	68	
	110 x 80 x 85	110	104	92	80	80	74	62	0	50	35	68	
	80 x 130 x 70	80	74	62	0	130	124	112	100	50	20	53	
	130 x 80 x 70	130	124	112	100	80	74	62	0	50	20	53	
	80 x 130 x 85	80	74	62	0	130	124	112	100	50	35	68	
	130 x 80 x 85	130	124	112	100	80	74	62	0	50	35	68	
	80 x 180 x 70	80	74	62	0	180	174	162	150	50	20	53	
	180 x 80 x 70	180	174	162	150	80	74	62	0	50	20	53	
	80 x 180 x 85	80	74	62	0	180	174	162	150	50	35	68	
	180 x 80 x 85	180	174	162	150	80	74	62	0	50	35	68	
COVER	80 x 250 x 70	80	74	62	0	250	244	232	220	50	20	52	
	250 x 80 x 70	250	244	232	220	80	74	62	0	50	20	52	
	80 x 250 x 85	80	74	62	0	250	244	232	220	50	35	67	
	250 x 80 x 85	250	244	232	220	80	74	62	0	50	35	67	
BASE	100 x 100 x 75	100	94	82	0	100	94	82	60	55	20	58	
	100 x 100 x 100	100	94	82	0	100	94	82	60	80	20	83	
	125 x 125 x 75	125	119	105	0	125	119	105	70	55	20	58	
	125 x 125 x 100	125	119	105	0	125	119	105	70	80	20	83	
COVER + BASE	125 x 175 x 75	125	121	109	0	175	169	157	140	50	25	58	
	175 x 125 x 75	175	169	157	140	127	121	109	0	50	25	58	
	125 x 175 x 100	125	121	109	0	175	169	157	140	50	50	83	
	175 x 125 x 100	175	169	157	140	125	121	109	0	50	50	83	
	140 x 170 x 95	140	137	122	0	170	167	152	130	75	20	77	
	170 x 140 x 95	170	167	152	130	140	137	122	0	75	20	77	
MOUNTING PLATE	140 x 230 x 95	140	134	122	0	230	224	212	190	75	20	77	
	230 x 140 x 95	230	224	212	190	140	134	122	0	75	25	77	
	150 x 150 x 75	150	144	110	0	150	144	110	110	55	20	58	
	150 x 150 x 100	150	144	110	0	150	144	110	110	80	20	83	
	150 x 200 x 75	150	142	132	0	200	192	182	160	55	20	58	
	200 x 150 x 75	200	192	182	160	150	142	132	0	55	20	58	
	150 x 200 x 100	150	142	132	0	200	192	182	160	80	20	83	
	200 x 150 x 100	200	192	182	160	150	142	132	0	80	20	83	
	150 x 200 x 130	150	142	132	0	200	192	182	160	110	20	111	
	200 x 150 x 130	200	192	182	160	150	142	132	0	110	20	111	
	150 x 200 x 160	150	142	132	0	200	192	182	160	110	50	149	
	200 x 150 x 160	200	192	182	160	150	142	132	0	110	50	149	
Water proof	IP 66/67												
	Impact proof	IK 07/08											
		Temperature	ABS :-40~+85 PC:-40~+120										
	150 x 250 x 100		150	142	132	0	250	242	232	210	80	20	83
	250 x 150 x 100		250	242	232	210	150	142	132	0	80	20	83
	150 x 250 x 130		150	142	132	0	250	242	232	210	80	50	113
250 x 150 x 130	250	242	232	210	150	142	132	0	80	50	113		
Flammability	ABS :94-HB												
	PC : 94-HB, 94-V-0~5VA												
	200 x 200 x 100	200	193	132	0	200	193	132	120	80	20	82	
	200 x 200 x 130	200	193	132	0	200	193	132	120	110	20	111	
200 x 200 x 160	200	193	132	0	200	193	132	120	110	50	141		

PRODUCT CHARACTERISTICS

1. It will not be damaged even using for a long time because stainless steel hinge and draw latch are equipped.
2. Ring is equipped at correct place after processing so that it has perfect airtight and convenience to open to open and close.
3. We reinforce the thickness and structure to be used longer time.



MODEL AND SIZE

Size (cover included)	Product Model				Plate Model		Plate Size	
Width x Length x Height (mm)	ABS		PC		Steel Mounting Plate 1.6mm	Plastic Mounting Plate 3-4.5 mm	M1	M2
	Grey Cover	Transparent Cover	Grey Cover	Transparent Cover				
80 x 110 x 70	BC-AGH-081107	BC-ATH-081107	BC-CGH-081107	BC-CTH-081107	0811 S	0811 P	64	94
110 x 80 x 70	BC-AGH-110807	BC-ATH-110807	BC-CGH-110807	BC-CTH-110807	1108 S	1108 P	64	94
80 x 110 x 85	BC-AGH-081108	BC-ATH-081108	BC-CGH-081108	BC-CTH-081108	0811 S	0811 P	64	94
110 x 80 x 85	BC-AGH-110808	BC-ATH-110808	BC-CGH-110808	BC-CTH-110808	1108 S	1108 P	64	94
80 x 130 x 70	BC-AGH-081307	BC-ATH-081307	BC-CGH-081307	BC-CTH-081307	0813 S	0813 P	65	115
130 x 80 x 70	BC-AGH-130807	BC-ATH-130807	BC-CGH-130807	BC-CTH-130807	1308 S	1308 P	65	115
80 x 130 x 85	BC-AGH-081308	BC-ATH-081308	BC-CGH-081308	BC-CTH-081308	0813 S	0813 P	65	115
130 x 80 x 85	BC-AGH-130808	BC-ATH-130808	BC-CGH-130808	BC-CTH-130808	1308 S	1308 P	65	115
80 x 180 x 70	BC-AGH-081807	BC-ATH-081807	BC-CGH-081807	BC-CTH-081807	0818 S	0818 P	65	165
180 x 80 x 70	BC-AGH-180807	BC-ATH-180807	BC-CGH-180807	BC-CTH-180807	1808 S	1808 P	65	165
80 x 180 x 85	BC-AGH-081808	BC-ATH-081808	BC-CGH-081808	BC-CTH-081808	0818 S	0818 P	65	165
180 x 80 x 85	BC-AGH-180808	BC-ATH-180808	BC-CGH-180808	BC-CTH-180808	1808 S	1808 P	65	165
80 x 250 x 70	BC-AGH-082507	BC-ATH-082507	BC-CGH-082507	BC-CTH-082507	0825 S	0825 P	65	235
250 x 80 x 70	BC-AGH-250807	BC-ATH-250807	BC-CGH-250807	BC-CTH-250807	2508 S	2508 P	65	235
80 x 250 x 85	BC-AGH-082508	BC-ATH-082508	BC-CGH-082508	BC-CTH-082508	0825 S	0825 P	65	235
250 x 80 x 85	BC-AGH-250808	BC-ATH-250808	BC-CGH-250808	BC-CTH-250808	2508 S	2508 P	65	235
100 x 100 x 75	BC-AGH-101007	BC-ATH-101007	BC-CGH-101007	BC-CTH-101007	1010 S	1010 P	82	82
100 x 100 x 100	BC-AGH-101010	BC-ATH-101010	BC-CGH-101010	BC-CTH-101010	1010 S	1010 P	82	82
125 x 125 x 75	BC-AGH-121207	BC-ATH-121207	BC-CGH-121207	BC-CTH-121207	1212 S	1212 P	107	107
125 x 125 x 100	BC-AGH-121210	BC-ATH-121210	BC-CGH-121210	BC-CTH-121210	1212 S	1212 P	107	107
125 x 175 x 75	BC-AGH-121707	BC-ATH-121707	BC-CGH-121707	BC-CTH-121707	1217 S	1217 P	113	161
175 x 125 x 75	BC-AGH-171207	BC-ATH-171207	BC-CGH-171207	BC-CTH-171207	1712 S	1712 P	113	161
125 x 175 x 100	BC-AGH-121710	BC-ATH-121710	BC-CGH-121710	BC-CTH-121710	1217 S	1217 P	113	161
175 x 125 x 100	BC-AGH-171210	BC-ATH-171210	BC-CGH-171210	BC-CTH-171210	1712 S	1712 P	113	161
140 x 170 x 95	BC-AGH-141709	BC-ATH-141709	BC-CGH-141709	BC-CTH-141709	1417 S	1417 P	126	155
170 x 140 x 95	BC-AGH-171409	BC-ATH-171409	BC-CGH-171409	BC-CTH-171409	1714 S	1714 P	126	155
140 x 230 x 95	BC-AGH-142309	BC-ATH-142309	BC-CGH-142309	BC-CTH-142309	1423 S	1423 P	122	212
230 x 140 x 95	BC-AGH-231409	BC-ATH-231409	BC-CGH-231409	BC-CTH-231409	2314 S	2314 P	122	212
150 x 150 x 75	BC-AGH-151507	BC-ATH-151507	BC-CGH-151507	BC-CTH-151507	1515 S	1515 P	123	123
150 x 150 x 100	BC-AGH-151510	BC-ATH-151510	BC-CGH-151510	BC-CTH-151510	1515 S	1515 P	123	123
150 x 200 x 75	BC-AGH-152007	BC-ATH-152007	BC-CGH-152007	BC-CTH-152007	1520 S	1520 P	129	179
200 x 150 x 75	BC-AGH-201507	BC-ATH-201507	BC-CGH-201507	BC-CTH-201507	2015 S	2015 P	129	179
150 x 200 x 100	BC-AGH-152010	BC-ATH-152010	BC-CGH-152010	BC-CTH-152010	1520 S	1520 P	129	179
200 x 150 x 100	BC-AGH-201510	BC-ATH-201510	BC-CGH-201510	BC-CTH-201510	2015 S	2015 P	129	179
150 x 200 x 130	BC-AGH-152013	BC-ATH-152013	BC-CGH-152013	BC-CTH-152013	1520 S	1520 P	129	179
200 x 150 x 130	BC-AGH-201513	BC-ATH-201513	BC-CGH-201513	BC-CTH-201513	2015 S	2015 P	129	179
150 x 200 x 160	BC-AGH-152016	BC-ATH-152016	BC-CGH-152016	BC-CTH-152016	1520 S	1520 P	129	179
200 x 150 x 160	BC-AGH-201516	BC-ATH-201516	BC-CGH-201516	BC-CTH-201516	2015 S	2015 P	129	179
150 x 250 x 100	BC-AGH-152510	BC-ATH-152510	BC-CGH-152510	BC-CTH-152510	1525 S	1525 P	129	224
250 x 150 x 100	BC-AGH-251510	BC-ATH-251510	BC-CGH-251510	BC-CTH-251510	2515 S	2515 P	129	224
150 x 250 x 130	BC-AGH-152513	BC-ATH-152513	BC-CGH-152513	BC-CTH-152513	1525 S	1525 P	129	224
250 x 150 x 130	BC-AGH-251513	BC-ATH-251513	BC-CGH-251513	BC-CTH-251513	2515 S	2515 P	129	224
200 x 200 x 100	BC-AGH-202010	BC-ATH-202010	BC-CGH-202010	BC-CTH-202010	2020 S	2020 P	179	179
200 x 200 x 130	BC-AGH-202013	BC-ATH-202013	BC-CGH-202013	BC-CTH-202013	2020 S	2020 P	179	179
200 x 200 x 160	BC-AGH-202016	BC-ATH-202016	BC-CGH-202016	BC-CTH-202016	2020 S	2020 P	179	179

ACCESSORIES

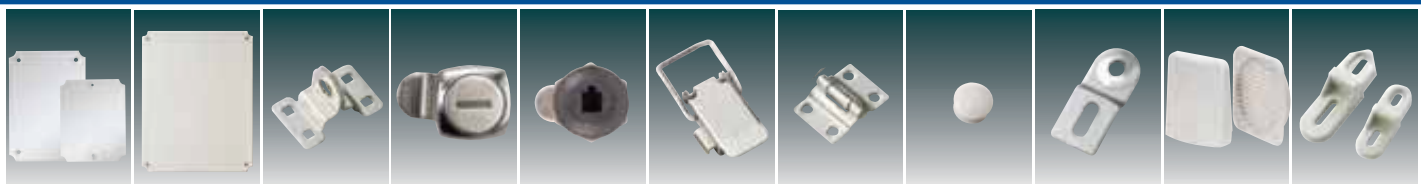

Steel mounting plate (Zinc plating) Plastic mounting plate (ABS) Key ring (K 40) Locker (SK) Plastic locker (PK) Draw latch (M55) Hinge (H55) Stopper (M11) Wall mounting bracket (B40, B50, B60) Vent (V60, V80) Plastic bracket (PB25,20)



The dimension of mounting plate is based on the plastic mounting plate and the dimension with a round bracket is steel mounting plate

DIMENSION (± 1 mm)

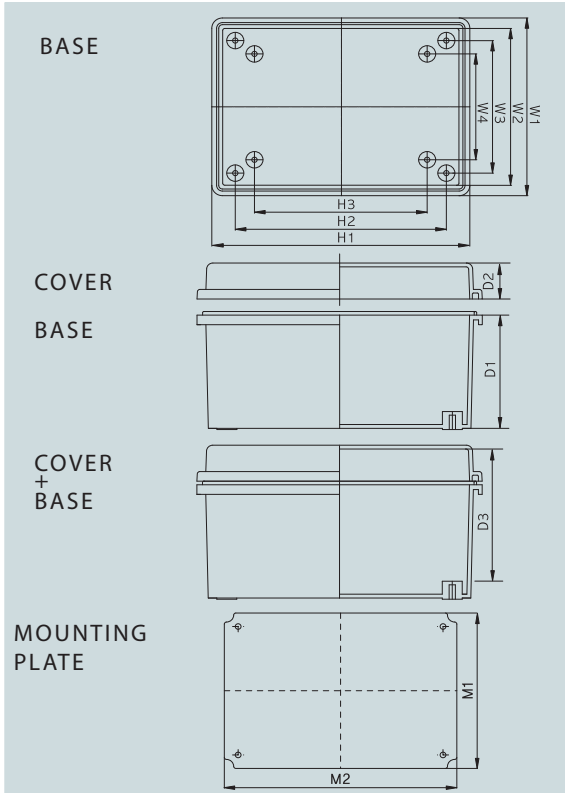

Size	Division				W1	W2	W3	W4	H1	H2	H3	H4	D1	D2	D3
	W1	W2	W3	W4											
225 x 275 x 120	225	219	204.6	183	276	270	234	210	90	30	98				
275 x 225 x 120	276	270	234	210	225	219	204	183	90	30	98				
200 x 300 x 150	200	180	152	129	300	280	252	226	120	30	128.5				
300 x 200 x 150	300	280	252	226	200	180	152	129	120	30	128.5				
200 x 300 x 180	200	180	152	129	300	280	252	226	150	30	158.5				
300 x 200 x 180	300	280	252	226	200	180	152	129	150	30	158.5				
250 x 350 x 150	250	230	206	180	350	330	306	269	120	30	128.5				
350 x 250 x 150	350	330	306	269	250	230	206	180	120	30	128.5				
300 x 400 x 150	300	280	252	230	400	380	352	325	120	30	128				
400 x 300 x 150	400	380	352	325	300	280	252	230	120	30	128				
300 x 400 x 180	300	280	252	230	400	380	352	325	150	30	158				
400 x 300 x 180	400	380	352	325	300	280	252	230	150	30	158				
350 x 450 x 160	350	323	298	276	450	423	398	376	130	30	138				
450 x 350 x 160	450	423	398	376	350	323	298	276	130	30	138				
350 x 450 x 200	350	323	298	276	450	423	398	376	170	30	178				
450 x 350 x 200	450	423	398	376	350	323	298	276	170	30	178				
400 x 500 x 200	402	375	352	328	502	475	452	428	170	30	178				
500 x 400 x 200	502	475	452	428	402	375	352	328	170	30	178				
400 x 600 x 230	402	375	352	328	602	575	552	525	200	30	208				
600 x 400 x 230	602	575	552	525	402	375	352	328	200	30	208				

Water proof	IP 66/67
Impact proof	IK 07/08
Temperature	ABS : -40~+85 PC: -40~+120
Flammability	ABS : 94-HB PC : 94-HB, 94-V-0~5VA

PRODUCT CHARACTERISTICS

1. The enclosure is equipped with stainless steel hinge and draw latch ensuring a long lasting service life.
2. The size of hinge and draw latch is increased with respect to the size of the enclosure. This provides the enclosure with perfect air tightness.
3. The enclosure is constructed using strong material and structure which can be used in inferior or dangerous industrial fields.



MODEL AND SIZE

Size (cover included)	Product Model				Plate Model		Plate Size	
	ABS		PC		Steel Mounting Plate 1.6mm	Plastic Mounting Plate 3~4.5 mm	M1	M2
Width x Length x Height (mm)	Grey Cover	Tranparent Cover	Grey Cover	Tranparent Cover				
225 x 275 x 120	BC-AGH-222712	BC-ATH-222712	BC-CGH-222712	BC-CTH-222712	2227 S	2227 P	190	242
275 x 225 x 120	BC-AGH-272212	BC-ATH-272212	BC-CGH-272212	BC-CTH-272212	2227 S	2227 P	190	242
200 x 300 x 150	BC-AGH-203015	BC-ATH-203015	BC-CGH-203015	BC-CTH-203015	2030 S	2030 P	166	266
300 x 200 x 150	BC-AGH-302015	BC-ATH-302015	BC-CGH-302015	BC-CTH-302015	2030 S	2030 P	166	266
200 x 300 x 180	BC-AGH-203018	BC-ATH-203018	BC-CGH-203018	BC-CTH-203018	2030 S	2030 P	166	266
300 x 200 x 180	BC-AGH-302018	BC-ATH-302018	BC-CGH-302018	BC-CTH-302018	2030 S	2030 P	166	266
250 x 350 x 150	BC-AGH-253515	BC-ATH-253515	BC-CGH-253515	BC-CTH-253515	2535 S	2535 P	216	316
350 x 250 x 150	BC-AGH-352515	BC-ATH-352515	BC-CGH-352515	BC-CTH-352515	2535 S	2535 P	216	316
300 x 400 x 150	BC-AGH-304015	BC-ATH-304015	BC-CGH-304015	BC-CTH-304015	3040 S	3040 P	265	365
400 x 300 x 150	BC-AGH-403015	BC-ATH-403015	BC-CGH-403015	BC-CTH-403015	3040 S	3040 P	265	365
300 x 400 x 180	BC-AGH-304018	BC-ATH-304018	BC-CGH-304018	BC-CTH-304018	3040 S	3040 P	265	365
400 x 300 x 180	BC-AGH-403018	BC-ATH-403018	BC-CGH-403018	BC-CTH-403018	3040 S	3040 P	265	365
350 x 450 x 160	BC-AGH-354516	BC-ATH-354516	BC-CGH-354516	BC-CTH-354516	3545 S	3545 P	306	407
450 x 350 x 160	BC-AGH-453516	BC-ATH-453516	BC-CGH-453516	BC-CTH-453516	3545 S	3545 P	306	407
350 x 450 x 200	BC-AGH-354520	BC-ATH-354520	BC-CGH-354520	BC-CTH-354520	3545 S	3545 P	306	407
450 x 350 x 200	BC-AGH-453520	BC-ATH-453520	BC-CGH-453520	BC-CTH-453520	3545 S	3545 P	306	407
400 x 500 x 200	BC-AGH-405020	BC-ATH-405020	BC-CGH-405020	BC-CTH-405020	4050 S	4050 P	358	458
500 x 400 x 200	BC-AGH-504020	BC-ATH-504020	BC-CGH-504020	BC-CTH-504020	4050 S	4050 P	358	458
400 x 600 x 230	BC-AGH-406023	BC-ATH-406023	BC-CGH-406023	BC-CTH-406023	4060 S	4060 P	358	458
600 x 400 x 230	BC-AGH-604023	BC-ATH-604023	BC-CGH-604023	BC-CTH-604023	4060 S	4060 P	358	458

ACCESSORIES



Steel mounting plate(Zinc plating)



Plastic mounting plate(ABS)



Key ring(K40)



Locker (SK)



Plastic locker (PK)

 Wall mounting bracket
(B40, B50, B60)

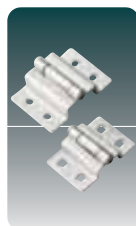
 Draw latch
(M65, M75)

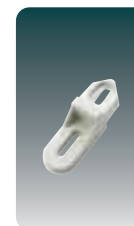
 Hinge
(H65, H75)

 Vent
(V60, V80)

 Plastic bracket
(PB 25)



The dimension of mounting plate is based on the plastic mounting plate and the dimension with a round bracket is steel mounting plate

DIMENSION (±1 mm)

	Division	Size										
		W1	W2	W3	W4	H1	H2	H3	H4	D1	D2	D3
BASE	190 x 190 x 130	190	170	165	120	190	170	165	120	98	30	112
	190 x 280 x 130	190	170	165	120	280	266	255	210	98	30	112
	280 x 190 x 130	280	266	255	210	190	170	165	120	98	30	112
	190 x 280 x 180	190	170	165	120	280	266	255	210	150	30	159
COVER	280 x 190 x 180	280	266	255	210	190	170	165	210	150	30	159
	190 x 380 x 130	190	170	165	120	380	359	355	310	98	30	109
	380 x 190 x 130	380	359	355	310	190	170	165	120	98	30	109
	190 x 380 x 180	190	170	165	120	380	360	355	310	150	30	159
BASE	380 x 190 x 180	380	359	355	310	190	170	165	210	150	30	159
	280 x 280 x 130	280	265	265	210	280	210	255	210	98	30	112
	280 x 340 x 130	280	259	254.7	210	340	319	315	270	100	30	111
	340 x 280 x 130	340	319	315	270	280	259	254.7	210	100	30	111
COVER + BASE	280 x 380 x 130	280	266	255	210	380	359	315	310	98	30	111
	380 x 280 x 130	380	359	355	310	280	266	255	210	98	30	111
	280 x 380 x 180	280	266	255	210	380	359	355	310	148	30	161.5
	380 x 280 x 180	380	359	355	310	280	266	255	210	148	30	161.5
MOUNTING PLATE	280 x 560 x 130	280	266	255	210	560	535	505	490	100	30	120
	560 x 280 x 130	560	535	505	490	280	266	255	210	100	30	120
	330 x 430 x 180	330	310	266	250	430	410	386	350	150	30	160
	430 x 330 x 180	430	410	386	350	330	310	266	250	150	30	160
	380 x 560 x 180	380	366	355	310	560	535	505	490	150	30	160
	560 x 380 x 180	560	535	505	490	380	366	355	310	150	30	160

Water proof	IP 66/67
Impact proof	IK 07/08
Temperature	ABS : -40~+85 PC: -40~+120
Flammability	ABS : 94-HB PC : 94-HB, 94-V-0~5VA

PRODUCT CHARACTERISTICS

1. The enclosure is equipped with stainless steel hinge and draw latch ensuring a long lasting service life.
2. It is designed to give excellent air tightness. Hinge and draw latch are made of stainless steel.
3. Holes can be easily made on the enclosure.



MODEL AND SIZE

Size (cover included)	Product Model				Plate Model		Plate Size	
	ABS		PC		Steel Mounting Plate 1.6mm	Plastic Mounting Plate 3~4.5 mm	M1	M2
Width x Length x Height (mm)	Grey Cover	Transparent Cover	Grey Cover	Transparent Cover				
190 x 190 x 130	BC-AGH-191913	BC-ATH-191913	BC-CGH-191913	BC-CTH-191913	1919 S	1919 P	159	159
190 x 280 x 130	BC-AGH-192813	BC-ATH-192813	BC-CGH-192813	BC-CTH-192813	1928 S	1928 P	159	248
280 x 190 x 130	BC-AGH-281913	BC-ATH-281913	BC-CGH-281913	BC-CTH-281913	2819 S	2819 P	159	248
190 x 280 x 180	BC-AGH-192818	BC-ATH-192818	BC-CGH-192818	BC-CTH-192818	1928 S	1928 P	159	248
280 x 190 x 180	BC-AGH-281918	BC-ATH-281918	BC-CGH-281918	BC-CTH-281918	2819 S	2819 P	159	248
190 x 380 x 130	BC-AGH-193813	BC-ATH-193813	BC-CGH-193813	BC-CTH-193813	1938 S	1938 P	159	348
380 x 190 x 130	BC-AGH-381913	BC-ATH-381913	BC-CGH-381913	BC-CTH-381913	3819 S	3819 P	159	348
190 x 380 x 180	BC-AGH-193818	BC-ATH-193818	BC-CGH-193818	BC-CTH-193818	1938 S	1938 P	159	348
380 x 190 x 180	BC-AGH-381918	BC-ATH-381918	BC-CGH-381918	BC-CTH-381918	3819 S	3819 P	159	348
280 x 280 x 130	BC-AGH-282813	BC-ATH-282813	BC-CGH-282813	BC-CTH-282813	2828 S	2828 P	248	248
280 x 340 x 130	BC-AGH-283413	BC-ATH-283413	BC-CGH-283413	BC-CTH-283413	2834 S	2834 P	248	308
340 x 280 x 130	BC-AGH-342813	BC-ATH-342813	BC-CGH-342813	BC-CTH-342813	3428 S	3428 P	308	248
280 x 380 x 130	BC-AGH-283813	BC-ATH-283813	BC-CGH-283813	BC-CTH-283813	2838 S	2838 P	248	348
380 x 280 x 130	BC-AGH-382813	BC-ATH-382813	BC-CGH-382813	BC-CTH-382813	3828 S	3828 P	248	348
280 x 380 x 180	BC-AGH-283818	BC-ATH-283818	BC-CGH-283818	BC-CTH-283818	2838 S	2838 P	248	348
380 x 280 x 180	BC-AGH-382818	BC-ATH-382818	BC-CGH-382818	BC-CTH-382818	3828 S	3828 P	348	348
280 x 560 x 130	BC-AGH-285613	BC-ATH-285613	BC-CGH-285613	BC-CTH-285613	2856 S		(232)	(535)
560 x 280 x 130	BC-AGH-562813	BC-ATH-562813	BC-CGH-562813	BC-CTH-562813	5828 S		(232)	(535)
330 x 430 x 180	BC-AGH-334318	BC-ATH-334318	BC-CGH-334318	BC-CTH-334318	3343 S	3343 P	(295)	(395)
430 x 330 x 180	BC-AGH-433318	BC-ATH-433318	BC-CGH-433318	BC-CTH-433318	4333 S	4333 P	(295)	(395)
380 x 560 x 180	BC-AGH-385618	BC-ATH-385618	BC-CGH-385618	BC-CTH-385618	3856 S		(345)	(535)
560 x 380 x 180	BC-AGH-563818	BC-ATH-563818	BC-CGH-563818	BC-CTH-563818	5638 S		(345)	(535)

560 x 280 x 130, 560 x 380 x 180 is for non water proof product.

ACCESSORIES

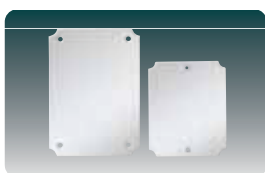

Steel mounting plate (Zinc plating)



Plastic mounting plate (ABS)



Key ring (K 40)



Lock (S K)

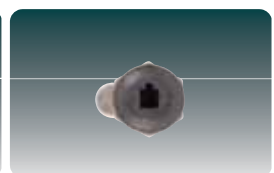

Plastic locker (P K)



Wall mounting bracket (B50)

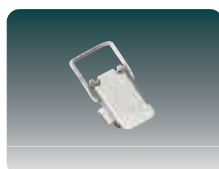

Draw latch (M 65)

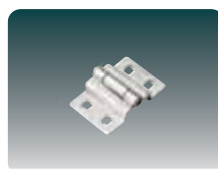

Hinge (H 65)



Stopper (M 22)



Vent (V60, V80)



Plastic bracket (PB25)

KNOCK-OUT BOX



DIMENSION (+1 mm)

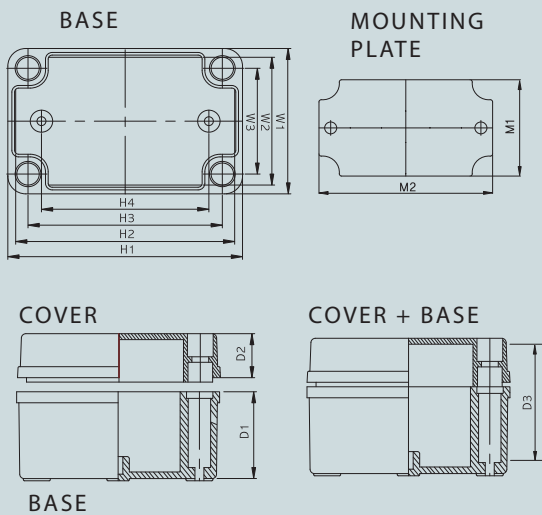

Size	Division									
	W1	W2	W3	H1	H2	H3	H4	D1	D2	D3
80 x 110 x 70	80	74	62	110	104	92	80	50	20	53
80 x 110 x 85	80	74	62	110	104	92	80	50	35	68
80 x 130 x 70	80	74	62	130	124	112	100	50	20	53
80 x 130 x 85	80	74	62	130	124	112	100	50	35	68
80 x 180 x 70	80	74	62	180	174	162	150	50	20	53
80 x 180 x 85	80	74	62	180	174	162	150	50	35	68
80 x 250 x 70	80	74	62	250	244	232	220	50	20	52
80 x 250 x 85	80	74	62	250	244	232	220	50	35	67
125 x 175 x 75	125	121	109	175	169	157	140	50	25	58
125 x 175 x 100	125	121	109	175	169	157	140	50	50	83

Water proof	IP 66/67	Impact proof	IK 07/08
Temperature	ABS :-40~+85 PC:-40~+120		
Flammability	ABS :94-HB, PC : 94-HB, 94-V-0~5VA		

MODEL AND SIZE

Size (cover included)	Product Model				Plate Model		Plate Size	
	ABS		PC		Steel Mounting Plate 1.6mm	Plastic Mounting Plate 3~4.5 mm	M1	M2
	Grey Cover	Transparent Cover	Grey Cover	Transparent Cover				
80 x 110 x 70	BC-AGS-081107-K	BC-ATS-081107-K	BC-CGS-081107-K	BC-CTS-081107-K				
80 x 110 x 85	BC-AGS-081108-K	BC-ATS-081108-K	BC-CGS-081108-K	BC-CTS-081108-K				
80 x 130 x 70	BC-AGS-081307-K	BC-ATS-081307-K	BC-CGS-081307-K	BC-CTS-081307-K				
80 x 130 x 85	BC-AGS-081308-K	BC-ATS-081308-K	BC-CGS-081308-K	BC-CTS-081308-K				
80 x 180 x 70	BC-AGS-081807-K	BC-ATS-081807-K	BC-CGS-081807-K	BC-CTS-081807-K				
80 x 180 x 85	BC-AGS-081808-K	BC-ATS-081808-K	BC-CGS-081808-K	BC-CTS-081808-K				
80 x 250 x 70	BC-AGS-082507-K	BC-ATS-082507-K	BC-CGS-082507-K	BC-CTS-082507-K				
80 x 250 x 85	BC-AGS-082508-K	BC-ATS-082508-K	BC-CGS-082508-K	BC-CTS-082508-K				
125 x 175 x 75	BC-AGS-121707-K	BC-ATS-121707-K	BC-CGS-121707-K	BC-CTS-121707-K	1217 S	1217 P	101	156
125 x 175 x 100	BC-AGS-121710-K	BC-ATS-121710-K	BC-CGS-121710-K	BC-CTS-121710-K	1217 S	1217 P	101	156

BOXCO PUSH BUTTON PLASTIC BOX



DIMENSION (±1 mm)

PUSH BUTTON HOLE

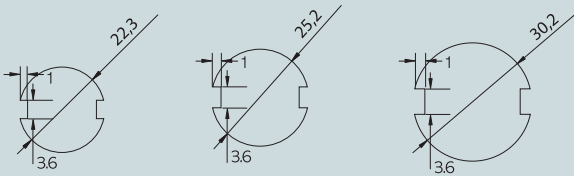

PUSH BUTTON HOLE SPACING

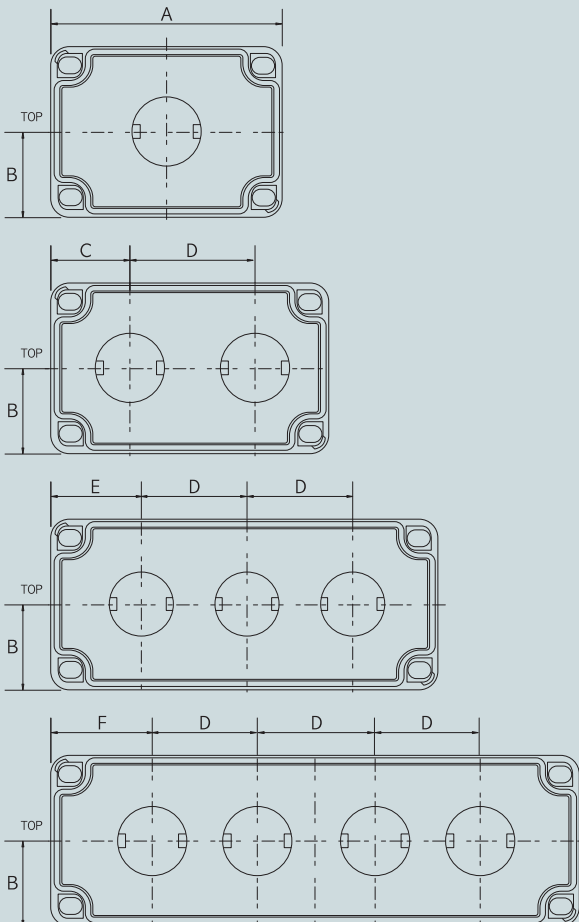

Cat. No.	Division	HOLE	A	B	C	D	E	F
BC-□GS-08110□-□□01	1-Hole	55	40					
BC-□GS-08130□-□□02	2-Hole	-	40	40	50			
BC-□GS-08180□-□□03	3-Hole	-	40		50	40		
BC-□GS-08250□-□□04	4-Hole	-	40		50			50

MODEL AND SIZE

Ø	HOLE	Model		Width x Length x Height (Unit : mm)
		ABS	PC	
		BC-AGS-xxxxxx	BC-CGS-xxxxxx	
220	1 HOLE	BC-AGS-081107-2201	BC-AGS-081107-2201	80 x 110 x 70
		BC-AGS-081108-2201	BC-AGS-081108-2201	80 x 110 x 85
	2 HOLE	BC-AGS-081307-2202	BC-AGS-081307-2202	80 x 130 x 70
		BC-AGS-081308-2202	BC-AGS-081308-2202	80 x 130 x 85
3 HOLE	BC-AGS-081807-2203	BC-AGS-081807-2203	80 x 180 x 70	
	BC-AGS-081808-2203	BC-AGS-081808-2203	80 x 180 x 85	
250	1 HOLE	BC-AGS-082507-2204	BC-AGS-082507-2204	80 x 250 x 70
		BC-AGS-082508-2204	BC-AGS-082508-2204	80 x 250 x 85
	2 HOLE	BC-AGS-081107-2501	BC-AGS-081107-2501	80 x 110 x 70
		BC-AGS-081108-2501	BC-AGS-081108-2501	80 x 110 x 85
3 HOLE	BC-AGS-081307-2502	BC-AGS-081307-2502	80 x 130 x 70	
	BC-AGS-081308-2502	BC-AGS-081308-2502	80 x 130 x 85	
300	3 HOLE	BC-AGS-081807-2503	BC-AGS-081807-2503	80 x 180 x 70
		BC-AGS-081808-2503	BC-AGS-081808-2503	80 x 180 x 85
	4 HOLE	BC-AGS-082507-2504	BC-AGS-082507-2504	80 x 250 x 70
		BC-AGS-082508-2504	BC-AGS-082508-2504	80 x 250 x 85
300	1 HOLE	BC-AGS-081107-3001	BC-AGS-081107-3001	80 x 110 x 70
		BC-AGS-081108-3001	BC-AGS-081108-3001	80 x 110 x 85
	2 HOLE	BC-AGS-081307-3002	BC-AGS-081307-3002	80 x 130 x 70
		BC-AGS-081308-3002	BC-AGS-081308-3002	80 x 130 x 85
3 HOLE	BC-AGS-081807-3003	BC-AGS-081807-3003	80 x 180 x 70	
	BC-AGS-081808-3003	BC-AGS-081808-3003	80 x 180 x 85	
4 HOLE	BC-AGS-082507-3004	BC-AGS-082507-3004	80 x 250 x 70	
	BC-AGS-082508-3004	BC-AGS-082508-3004	80 x 250 x 85	

* A = ABS, P = PC/ABS, C = PC

Water proof	IP 66/67, IK 07/08
Temperature	ABS :-40~+85 PC:-40~+120
Flammability	ABS :94-HB, PC :94-HB, 94-V-0-5VA

BOXCO PUSH BUTTON ALUMINIUM DIE CASTING BOX



DIMENSION

PUSH BUTTON HOLE

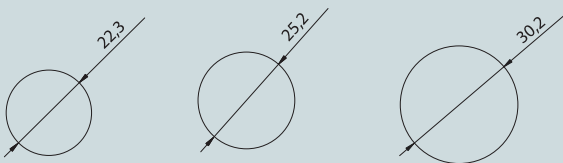

PUSH BUTTON HOLE SPACING

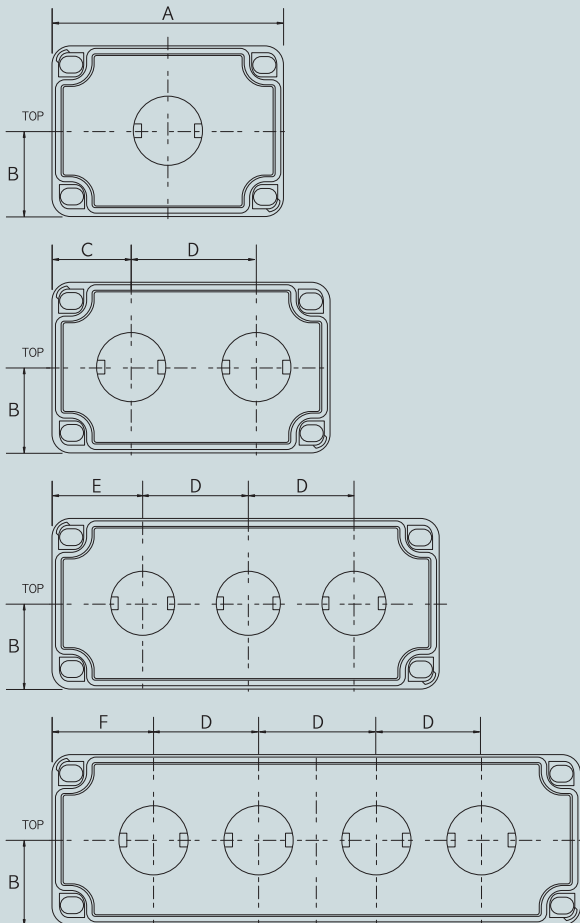

Cat. No.	Division HOLE	A	B	C	D	E	F
BC-AL-081306-□□02	2-Hole	-	40	38	50		
BC-AL-081806-□□03	3-Hole	-	40		50	38	
BC-AL-082506-□□04	4-Hole	-	40		50		50

MODEL AND SIZE

Ø	HOLE	Model	Width x Length x Height (Unit : mm)
22Ø	1 HOLE	BC-AL-080806-2201	80 x 75 x 57
	2 HOLE	BC-AL-081306-2202	80 x 125 x 57
	3 HOLE	BC-AL-081806-2203	80 x 175 x 57
	4 HOLE	BC-AL-082506-2204	80 x 250 x 57
25Ø	1 HOLE	BC-AL-080806-2501	80 x 75 x 57
	2 HOLE	BC-AL-081306-2502	80 x 125 x 57
	3 HOLE	BC-AL-081806-2503	80 x 175 x 57
	4 HOLE	BC-AL-082506-2504	80 x 250 x 57
30Ø	1 HOLE	BC-AL-080806-3001	80 x 75 x 57
	2 HOLE	BC-AL-081306-3002	80 x 125 x 57
	3 HOLE	BC-AL-081806-3003	80 x 175 x 57
	4 HOLE	BC-AL-082506-3004	80 x 250 x 57

Water proof IP 66/67, IK 09/10

ALUMINIUM DIE CASTING BOX



DIMENSION

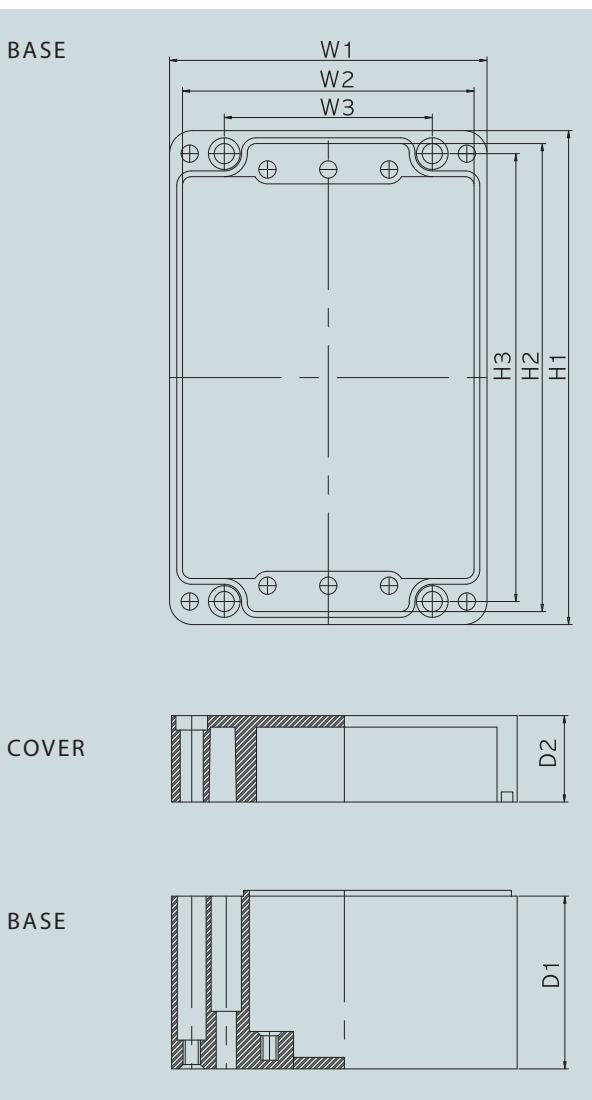

Size	Division							
	W1	W2	W3	H1	H2	H3	D1	D2
64 x 98 x 34	68	57.8	36	98	91.8	86	25	9
80 x 75 x 57	80	72	52	75	67	63	42	15
80 x 125 x 57	80	72	52	125	117	113	42	15
80 x 175 x 57	80	72	52	175	167	163	42	15
80 x 250 x 57	80	72	52	250	242	238	42	15
100 x 100 x 80	100	92	66	100	92	86	61	20
100 x 160 x 80	100	92	66	160	152	146	61	20
120 x 122 x 80	120	111	82	122	113	106	61	20
120 x 220 x 80	120	111	82	220	213	206	61	20
120 x 220 x 90	120	111	82	220	211	204	61	30
150 x 132 x 90	150	121	92	132	144	138	70	20
160 x 160 x 90	160	151	110	160	151	140	71	20
160 x 260 x 90	160	151	110	260	251	240	71	20
180 x 180 x 100	180	171	130	180	171	160	71	30
230 x 200 x 110	230	230	140	200	193	150	91	20
313 x 404 x 111	313	303	262	404	394	382	91	20
313 x 404 x 181	313	303	262	404	394	382	161	20

MODEL AND SIZE

Size (cover included) Width x Length x Height (Unit : mm)	Model	Plate Model	
	Aluminium Box	Steel Mounting Plate	Plastic Mounting Plate
64 x 98 x 34	BC-AL-061003	6010 A	
80 x 75 x 57	BC-AL-080806	0808 A	
80 x 125 x 57	BC-AL-081306	0813 A	
80 x 175 x 57	BC-AL-081806	0818 A	
80 x 250 x 57	BC-AL-082506	0825 A	
100 x 100 x 80	BC-AL-101008	1010 A	
100 x 160 x 80	BC-AL-101608	1016 A	
120 x 122 x 80	BC-AL-121208	1212 A	
120 x 220 x 80	BC-AL-122208	1222 A	
120 x 220 x 90	BC-AL-122209	1222 A	
150 x 132 x 90	BC-AL-151309	1513 A	
160 x 160 x 90	BC-AL-161609	1616 A	
160 x 260 x 90	BC-AL-162609	1626 A	1626 A P
180 x 180 x 100	BC-AL-181810	1818 A	
230 x 200 x 110	BC-AL-232011	2320 A	2320 A P
313 x 404 x 111	BC-AL-314011	3140 A	
313 x 404 x 181	BC-AL-314018	3140 A	

Water proof IP 66/67, IK 09/10

4P



BASE

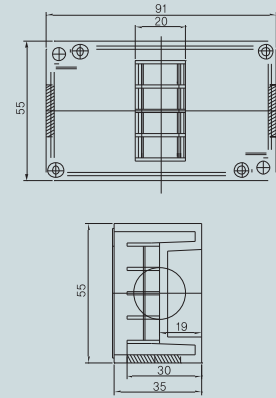

COVER

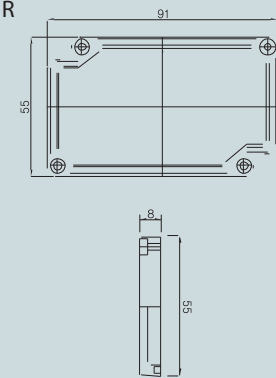

MODEL SIZE

External Size	Product Model			
	ABS (Grey)		ABS (Grayish blue)	
Width x Length x Height (mm)	(Opaque)	(Transparent)	(Opaque)	(Transparent)
	55x91x43x21	BC-AG-4P	BC-AG-4P (T)	BC-AB-4P
Water proof	IP 66/67		Impact proof	IK 07/08
Temperature	ABS :-40~+85 PC:-40~+120			
Flammability	ABS: 94-V-0			
Max. Voltage	400V		Isolation Voltage	4KV
Wire Size	0.75mm sq. - 1.5mm sq.			

4PH, 4P16H, 4P1618H, 4P1821H, 4P21H



BASE

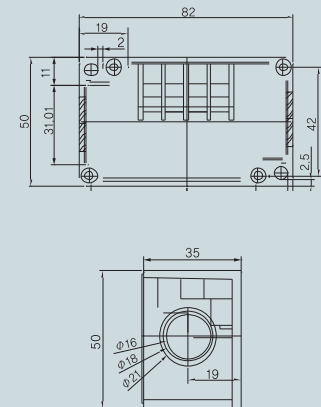

COVER

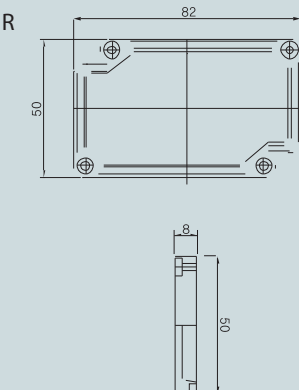

MODEL SIZE

External Size	Product Model			
	ABS (Grey)		ABS (Grayish blue)	
Width x Length x Height (mm)	(Opaque)	(Transparent)	(Opaque)	(Transparent)
	50x82x43x21	BC-AG-4PH	BC-AG-4PH (T)	BC-AB-4PH
50x82x43x16	BC-AG-4P16H	BC-AG-4P16H (T)	BC-AB-4P16H	BC-AB-4P16H (T)
50x82x43x16,18	BC-AG-4P1618H	BC-AG-4P1618H (T)	BC-AB-4P1618H	BC-AB-4P1618H (T)
50x82x43x18	BC-AG-4P18H	BC-AG-4P18H (T)	BC-AB-4P18H	BC-AB-4P18H (T)
50x82x43x18,21	BC-AG-4P1821H	BC-AG-4P1821H (T)	BC-AB-4P1821H	BC-AB-4P1821H (T)
50x82x43x21	BC-AG-4P21H	BC-AG-4P21H (T)	BC-AB-4P21H	BC-AB-4P21H (T)
Water proof	IP 66/67		Impact proof	IK 07/08
Temperature	ABS :-40~+85 PC:-40~+120			
Flammability	ABS: 94-V-0			
Max. Voltage	400V		Isolation Voltage	4KV
Wire Size	0.75mm sq. - 1.5mm sq.			

4P-T



BASE

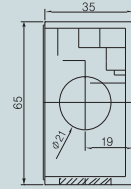
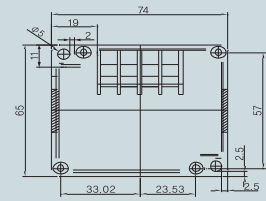

COVER

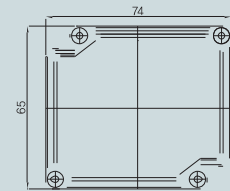

MODEL SIZE

External Size	Product Model			
	ABS (Grey)		ABS (Grayish blue)	
Width x Length x Height (mm)	(Opaque)	(Transparent)	(Opaque)	(Transparent)
65 x 74 x 43 x 21	BC-AG-4P-T	BC-AG-4P-T (T)	BC-AB-4P-T	BC-AB-4P-T (T)
Water proof	IP 66/67		Impact proof	IK 07/08
Temperature	ABS : -40~+85 PC: -40~+120			
Flammability	ABS : 94-V-0			
Max. Voltage	400V		Isolation Voltage	4KV
Wire Size	0.75mm sq. - 1.5mm sq.			

4P9, 4P911, 4P11, 4P1113, 4P13



BASE

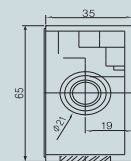
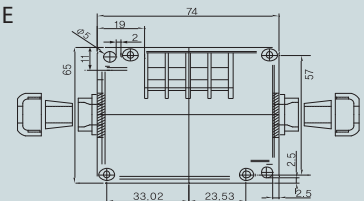

COVER

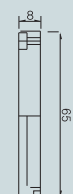
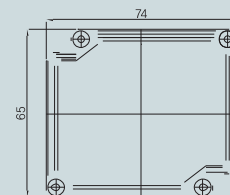

MODEL SIZE

External Size	Product Model			
	ABS (Grey)		ABS (Grayish blue)	
Width x Length x Height (mm)	(Opaque)	(Transparent)	(Opaque)	(Transparent)
50 x 82 x 43	BC-AG-4P9	BC-AG-4P9 (T)	BC-AB-4P9	BC-AB-4P9 (T)
50 x 82 x 43	BC-AG-4P911	BC-AG-4P911 (T)	BC-AB-4P911	BC-AB-4P911 (T)
50 x 82 x 43	BC-AG-4P11	BC-AG-4P11 (T)	BC-AB-4P11	BC-AB-4P11 (T)
50 x 82 x 43	BC-AG-4P1113	BC-AG-4P1113 (T)	BC-AB-4P1113	BC-AB-4P1113 (T)
50 x 82 x 43	BC-AG-4P13	BC-AG-4P13 (T)	BC-AB-4P13	BC-AB-4P13 (T)
Water proof	IP 66/67		Impact proof	IK 07/08
Temperature	ABS : -40~+85 PC: -40~+120			
Flammability	ABS : 94-V-0			
Max. Voltage	400V		Isolation Voltage	4KV
Wire Size	0.75mm sq. - 1.5mm sq.			

6P

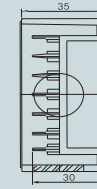
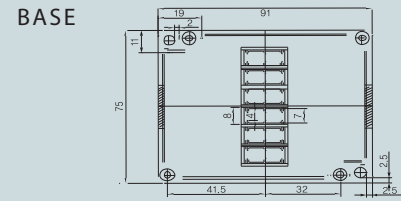

COVER

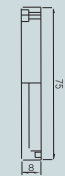
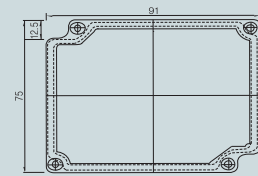

MODEL SIZE

External Size	Product Model			
	ABS (Grey)		ABS (Grayish blue)	
Width x Length x Height (mm)	(Opaque)	(Transparent)	(Opaque)	(Transparent)
75 x 91 x 43 x 21	BC-AG-6P	BC-AG-6P(T)	BC-AB-6P	BC-AB-6P(T)
Water proof	IP 66/67		Impact proof	IK 07/08
Temperature	ABS : -40~+85 PC: -40~+120			
Flammability	ABS : 94-V-0			
Max. Voltage	400V		Isolation Voltage	4KV
Wire Size	0.75mm sq. - 1.5mm sq.			

6PH, 6P18H, 6P1821H, 6P21H

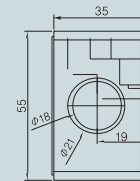
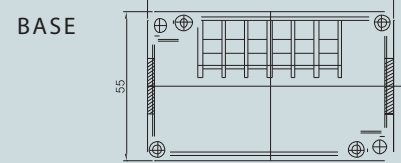

COVER

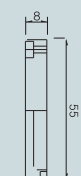
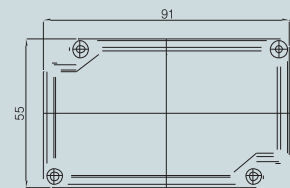

MODEL SIZE

External Size	Product Model			
	ABS (Grey)		ABS (Grayish blue)	
Width x Length x Height (mm)	(Opaque)	(Transparent)	(Opaque)	(Transparent)
55 x 91 x 43 x 21	BC-AG-6PH	BC-AG-6PH (T)	BC-AB-6PH	BC-AB-6PH (T)
55 x 91 x 43 x 18	BC-AG-6P18H	BC-AG-6P18H (T)	BC-AB-6P18H	BC-AB-6P18H (T)
55 x 91 x 43 x 18,21	BC-AG-6P1821H	BC-AG-6P1821H (T)	BC-AB-6P1821H	BC-AB-6P1821H (T)
55 x 91 x 43 x 21	BC-AG-6P21H	BC-AG-6P21H (T)	BC-AB-6P21H	BC-AB-6P21H (T)
Water proof	IP 66/67		Impact proof	IK 07/08
Temperature	ABS : -40~+85 PC: -40~+120			
Flammability	ABS : 94-V-0			
Max. Voltage	400V		Isolation Voltage	4KV
Wire Size	0.75mm sq. - 1.5mm sq.			

6P-T

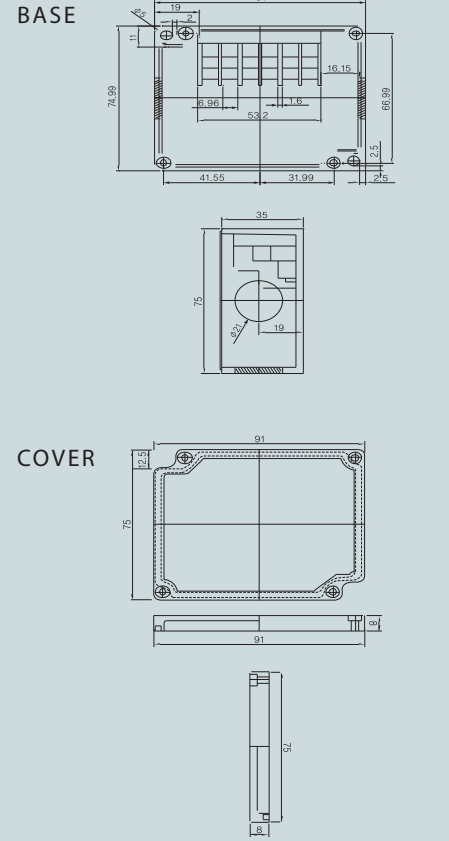

MODEL SIZE

External Size	Product Model			
	ABS (Grey)		ABS (Grayish blue)	
Width x Length x Height (mm)	(Opaque)	(Transparent)	(Opaque)	(Transparent)
75 x 91 x 43 x 21	BC-AG-6P-T	BC-AG-6P-T (T)	BC-AB-6P-T	BC-AB-6P-T (T)
Water proof	IP 66/67		Impact proof	IK 07/08
Temperature	ABS : -40~+85 PC: -40~+120			
Flammability	ABS : 94-V-0			
Max. Voltage	400V		Isolation Voltage	4KV
Wire Size	0.75mm sq. - 1.5mm sq.			

6P11, 6P1113, 6P13

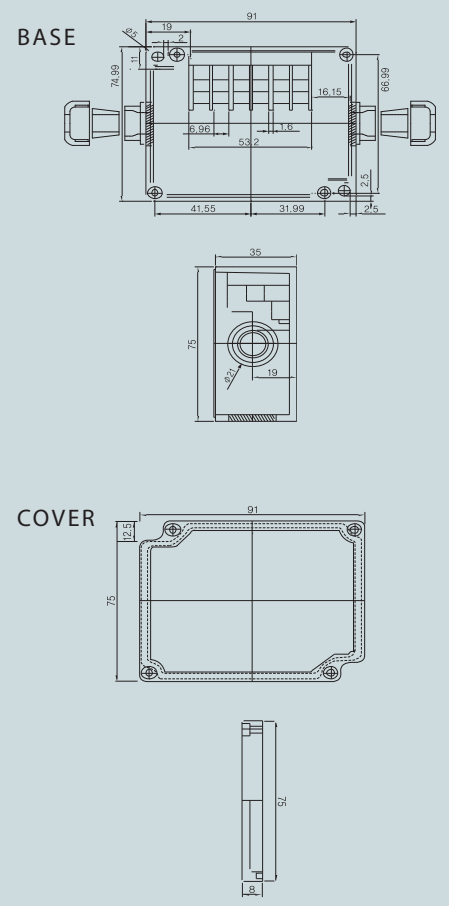

MODEL SIZE

External Size	Product Model			
	ABS (Grey)		ABS (Grayish blue)	
Width x Length x Height (mm)	(Opaque)	(Transparent)	(Opaque)	(Transparent)
55 x 91 x 43	BC-AG-611	BC-AG-611 (T)	BC-AB-611	BC-AB-611 (T)
55 x 91 x 43	BC-AG-6P1113	BC-AG-6P1113 (T)	BC-AB-6P1113	BC-AB-6P1113 (T)
55 x 91 x 43	BC-AG-6P13	BC-AG-6P13 (T)	BC-AB-6P13	BC-AB-6P13 (T)
Water proof	IP 66/67		Impact proof	IK 07/08
Temperature	ABS : -40~+85 PC: -40~+120			
Flammability	ABS : 94-V-0			
Max. Voltage	400V		Isolation Voltage	4KV
Wire Size	0.75mm sq. - 1.5mm sq.			

10P



BASE

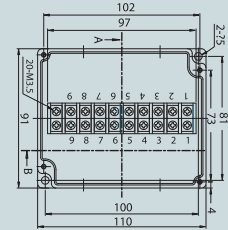
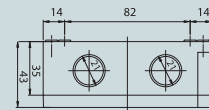

COVER

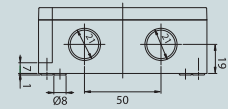
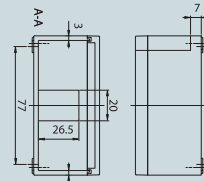

MODEL SIZE

External Size	Product Model			
	ABS (Grey)		ABS (Grayish blue)	
Width x Length x Height (mm)	(Opaque)	(Transparent)	(Opaque)	(Transparent)
75 x 125 x 43 x 21	BC-AG-10P	BC-AG-10P (T)	BC-AB-10P	BC-AB-10P (T)
Water proof	IP 66/67		Impact proof	IK 07/08
Temperature	ABS : -40~+85 PC: -40~+120			
Flammability	ABS : 94-V-0			
Max. Voltage	400V		Isolation Voltage	4KV
Wire Size	0.75mm sq. - 1.5mm sq.			

10P-T



BASE

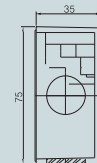
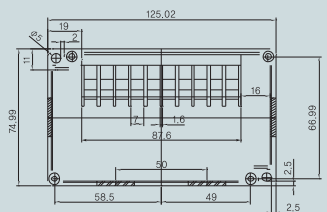

COVER

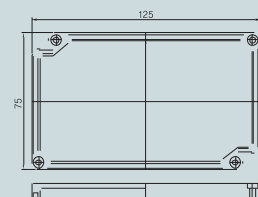

MODEL SIZE

External Size	Product Model			
	ABS (Grey)		ABS (Grayish blue)	
Width x Length x Height (mm)	(Opaque)	(Transparent)	(Opaque)	(Transparent)
75 x 125 x 43 x 21	BC-AG-10P-T	BC-AG-10P-T (T)	BC-AB-10P	BC-AB-10P-T (T)
Water proof	IP 66/67		Impact proof	IK 07/08
Temperature	ABS : -40~+85 PC: -40~+120			
Flammability	ABS : 94-V-0			
Max. Voltage	400V		Isolation Voltage	4KV
Wire Size	0.75mm sq. - 1.5mm sq.			

15P

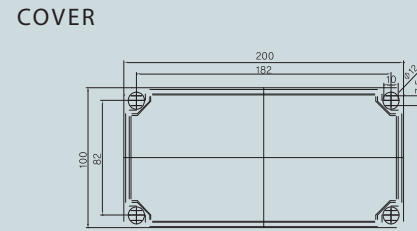
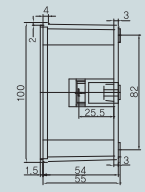
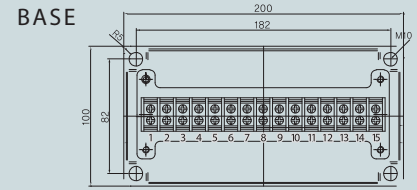

MODEL SIZE

External Size	Product Model			
	ABS (Grey)		ABS (Grayish blue)	
Width x Length x Height (mm)	(Opaque)	(Transparent)	(Opaque)	(Transparent)
100 x 185 x 70	BC-AG-15P	BC-AG-15P(T)	BC-AB-15P	BC-AB-15P(T)
Water proof	IP 66/67		Impact proof	IK 07/08
Temperature	ABS : -40~+85 PC: -40~+120			
Flammability	ABS : 94-V-0			
Max. Voltage	400V		Isolation Voltage	4KV
Wire Size	0.75mm sq. - 1.5mm sq.			

15P-T

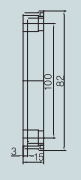
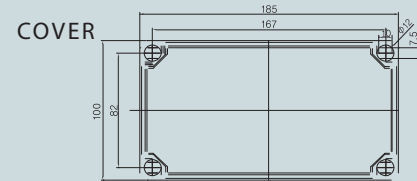
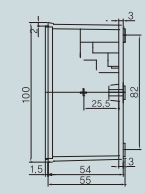
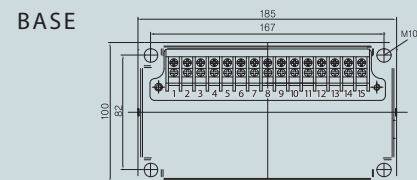

MODEL SIZE

External Size	Product Model			
	ABS (Grey)		ABS (Grayish blue)	
Width x Length x Height (mm)	(Opaque)	(Transparent)	(Opaque)	(Transparent)
100 x 185 x 70	BC-AG-15P-T	BC-AG-15P-T (T)	BC-AB-15P	BC-AB-15P-T (T)
Water proof	IP 66/67		Impact proof	IK 07/08
Temperature	ABS : -40~+85 PC: -40~+120			
Flammability	ABS : 94-V-0			
Max. Voltage	400V		Isolation Voltage	4KV
Wire Size	0.75mm sq. - 1.5mm sq.			

20P

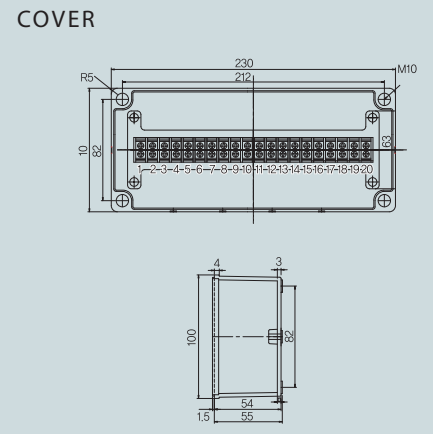
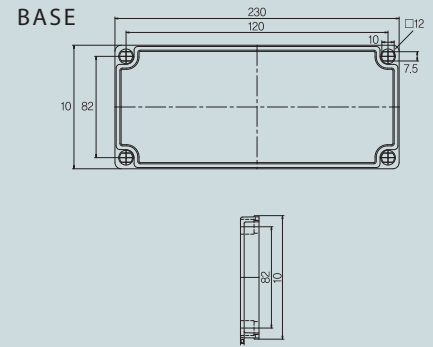

MODEL SIZE

External Size	Product Model			
	ABS (Grey)		ABS (Grayish blue)	
Width x Length x Height (mm)	(Opaque)	(Transparent)	(Opaque)	(Transparent)
100 x 230 x 70	BC-AG-20P	BC-AG-20P(T)	BC-AB-20P	BC-AB-20P(T)
Water proof	IP 66/67		Impact proof	IK 07/08
Temperature	ABS : -40~+85 PC: -40~+120			
Flammability	ABS: 94-V-0			
Max. Voltage	400V		Isolation Voltage	4KV
Wire Size	0.75mm sq. - 1.5mm sq.			

20P-T

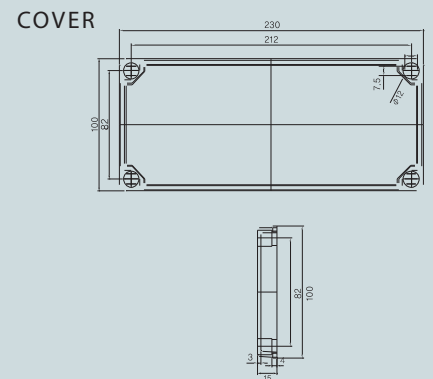
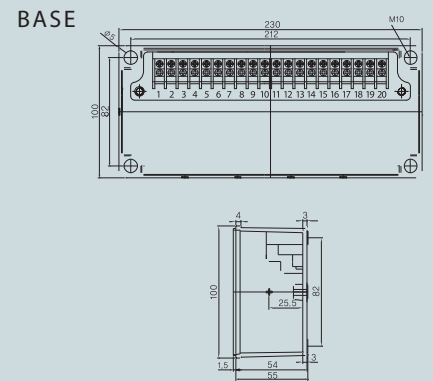

MODEL SIZE

External Size	Product Model			
	ABS (Grey)		ABS (Grayish blue)	
Width x Length x Height (mm)	(Opaque)	(Transparent)	(Opaque)	(Transparent)
100 x 230 x 70	BC-AG-20P-T	BC-AG-20P-T (T)	BC-AB-20P	BC-AB-20P-T (T)
Water proof	IP 66/67		Impact proof	IK 07/08
Temperature	ABS : -40~+85 PC: -40~+120			
Flammability	ABS: 94-V-0			
Max. Voltage	400V		Isolation Voltage	4KV
Wire Size	0.75mm sq. - 1.5mm sq.			

20P-A



BASE

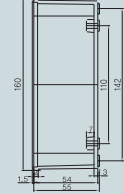
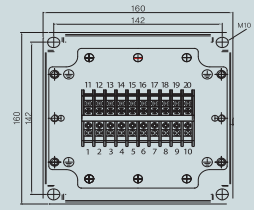

COVER

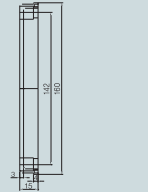
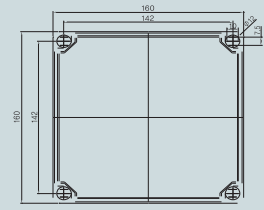

MODEL SIZE

External Size	Product Model			
	ABS (Grey)		ABS (Grayish blue)	
Width x Length x Height (mm)	(Opaque)	(Transparent)	(Opaque)	(Transparent)
	160 x 160 x 70	BC-AG-20P-A	BC-AG-20P-A(T)	BC-AB-20P-A
Water proof	IP 66/67		Impact proof	IK 07/08
Temperature	ABS : -40~+85 PC: -40~+120			
Flammability	ABS: 94-V-0			
Max. Voltage	400V		Isolation Voltage	4KV
Wire Size	0.75mm sq. - 1.5mm sq.			

20P-2



BASE

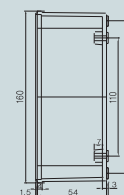
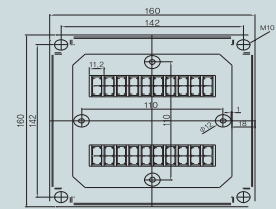

COVER

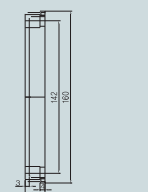
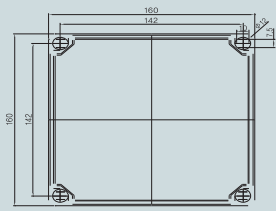

MODEL SIZE

External Size	Product Model			
	ABS (Grey)		ABS (Grayish blue)	
Width x Length x Height (mm)	(Opaque)	(Transparent)	(Opaque)	(Transparent)
	160 x 160 x 70	BC-AG-20P-2	BC-AG-20P-2 (T)	BC-AB-20P-2
Water proof	IP 66/67		Impact proof	IK 07/08
Temperature	ABS : -40~+85 PC: -40~+120			
Flammability	ABS: 94-V-0			
Max. Voltage	400V		Isolation Voltage	4KV
Wire Size	0.75mm sq. - 1.5mm sq.			

PBT-3P



MODEL SIZE

Model & Size Width x Length x Height x Hole (mm)	Product Model			
	PBT (Grey)		PBT (Black)	
	Grey	Transparent	Grey	Transparent
33 x 65 x 24 x 9.2	BC-PBT-3P	BC-PBT-3P-T	BC-PBB-3P	BC-PBB-3P-T
40 x 60 x 24 x 9.2	BC-PBT-4P	BC-PBT-4P-T	BC-PBB-4P	BC-PBB-4P-T
50 x 70 x 24 x 9.2	BC-PBT-6P	BC-PBT-6P-T	BC-PBB-6P	BC-PBB-6P-T
Temperature	PBT : -40~+100			
Flammability	PBT +GF15%, V-0			

DIMENSION

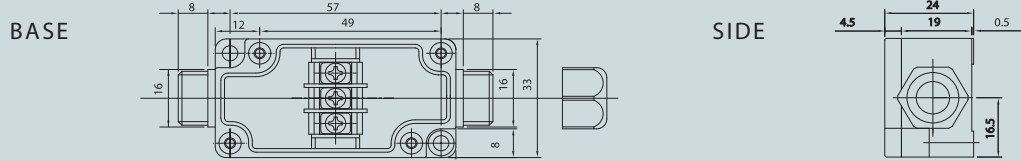

PBT-4P



MODEL SIZE

Model & Size Width x Length x Height x Hole (mm)	Product Model			
	PBT (Grey)		PBT (Black)	
	Grey	Transparent	Grey	Transparent
33 x 65 x 24 x 9.2	BC-PBT-3P	BC-PBT-3P-T	BC-PBB-3P	BC-PBB-3P-T
40 x 60 x 24 x 9.2	BC-PBT-4P	BC-PBT-4P-T	BC-PBB-4P	BC-PBB-4P-T
50 x 70 x 24 x 9.2	BC-PBT-6P	BC-PBT-6P-T	BC-PBB-6P	BC-PBB-6P-T
Temperature	PBT : -40~+100			
Flammability	PBT +GF15%, V-0			

DIMENSION

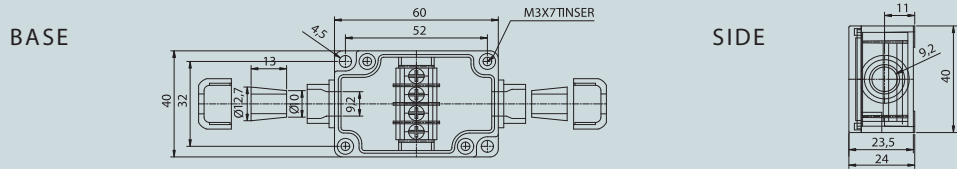

PBT-6P



MODEL SIZE

Model & Size Width x Length x Height x Hole (mm)	Product Model			
	PBT (Grey)		PBT (Black)	
	Grey	Transparent	Grey	Transparent
33 x 65 x 24 x 9.2	BC-PBT-3P	BC-PBT-3P-T	BC-PBB-3P	BC-PBB-3P-T
40 x 60 x 24 x 9.2	BC-PBT-4P	BC-PBT-4P-T	BC-PBB-4P	BC-PBB-4P-T
50 x 70 x 24 x 9.2	BC-PBT-6P	BC-PBT-6P-T	BC-PBB-6P	BC-PBB-6P-T
Temperature	PBT : -40~+100			
Flammability	PBT +GF15%, V-0			

DIMENSION

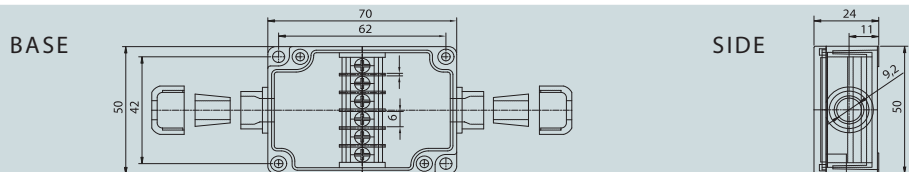

BC-PG CABLE GLAND



BASE

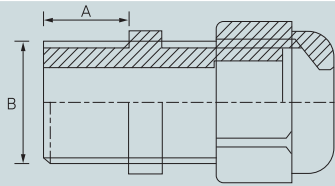

MODEL AND SIZE

Model No.			Size	A	B
Gray	Dark Gray	Black	Cable \varnothing mm	(mm)	(mm)
BC-PG7-G	BC-PG7-D	BC-PG7-B	3 ~ 6	8	12.5
BC-PG9-G	BC-PG9-D	BC-PG9-B	4 ~ 8	8	15.2
BC-PG11-G	BC-PG11-D	BC-PG11-B	5 ~ 10	8	18.6
BC-PG13.5-G	BC-PG13.5-D	BC-PG13.5-B	6 ~ 12	9	20.4
BC-PG16-G	BC-PG16-D	BC-PG16-B	10 ~ 14	10	22.5
BC-PG19-G	BC-PG19-D	BC-PG19-B	12 ~ 15	10	23.5
BC-PG21-G	BC-PG21-D	BC-PG21-B	13 ~ 18	10	28.3
BC-PG25-G	BC-PG25-D	BC-PG25-B	15 ~ 19	11	29.5
BC-PG29-G	BC-PG29-D	BC-PG29-B	18 ~ 25	12	37
BC-PG36-G	BC-PG36-D	BC-PG36-B	22 ~ 32	13.5	47
BC-PG42-G	BC-PG42-D	BC-PG42-B	30 ~ 38	14.5	54
BC-PG48-G	BC-PG48-D	BC-PG48-B	34 ~ 44	14	59
BC-PG63-G	BC-PG63-D	BC-PG63-B	42 ~ 50	27	70

BC-PG-L LONG CABLE GLAND



BASE

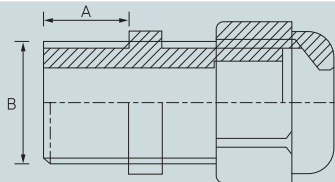

MODEL AND SIZE

Model No.	Size	A	B
Gray	Cable (\varnothing mm)	(mm)	(mm)
BC-PG7L-G	3.5 ~ 6	15	12
BC-PG9L-G	4 ~ 8	15	16
BC-PG11L-G	5 ~ 10	15	18
BC-PG13.5L-G	6 ~ 12	15	20
BC-PG16L-G	10 ~ 14	15	22

PRODUCT CHARACTERISTICS

Material : Nylon plastic
 Hermetic Seal : Nitrile rubber
 IP rating : IP66
 Ambient temperature : -20°C ~ 65°C
 Supply color : Grey

BC-BP-PG BEND PROOF CABLE GLAND



BASE

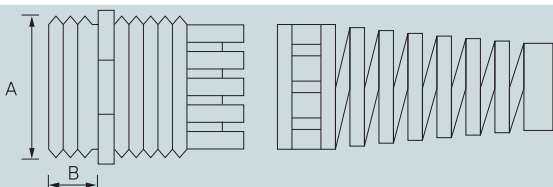

MODEL AND SIZE

Article No.	Cable Range (mm)	A (mm)	Panel Mounting Hole
BC-BP-PG7	3 ~ 5.5	12.5	12.5 ~ 12.8
BC-BP-PG9	8 ~ 4.5	15.2	15.2 ~ 15.5
BC-BP-PG11	6 ~ 10	18.6	18.6 ~ 18.9
BC-BP-PG13.5	7 ~ 12.5	20.4	20.4 ~ 20.7
BC-BP-PG16	8.5 ~ 14	22.5	22.5 ~ 22.8
BC-BP-PG21	12.5 ~ 18	28.3	28.3 ~ 28.7

PRODUCT CHARACTERISTICS

Material : Nylon plastic
 Hermetic Seal : Nitrile rubber
 Ambient temperature : quiescent state -40°C to 100°C, short time to 120°C dynamic -20°C to 80°C, short time to 100°C
 Supply color : Grey

BC-MPG METAL CABLE GLAND

BASE

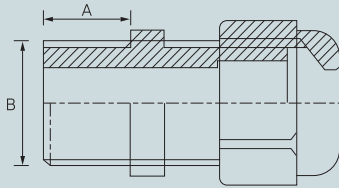
MODEL AND SIZE

Article No.	Thread Dimension	Clamping range (mm)	A (mm)	B (mm)	Wrench size (mm)
BC-MPG7	PG7	3 ~ 6.5	5	12.5	14
BC-MPG9	PG9	4 ~ 8	6	15.2	17
BC-MPG11	PG11	5 ~ 10	6	18.6	20
BC-MPG13	PG13.5	6 ~ 12	7	20.4	22
BC-MPG16	PG16	8 ~ 14	7	22.5	24
BC-MPG21	PG21	13 ~ 18	8	28.3	30
BC-MPG29	PG29	18 ~ 25	8	37	40
BC-MPG36	PG36	22 ~ 32	9	47	50
BC-MPG42	PG42	30 ~ 38	9	54	60
BC-MPG48	PG48	37 ~ 44	10	59.3	65

PRODUCT CHARACTERISTICS

Material : Body : Nickel-plated brass seal : Polymide 66, Sealing : NBR

Protection degree : Within the clamping range, its protection degree can reach IP68.

Properties : Succeed in the experiment of IEC-60077-1999 resistance vibration and impact.

Temperature Range : Stat : Min-40°C, Max 100°C, Short-term 120°C
Dyn. : Min-20°C, Max 80°C, Short-term 100°C

BC-PKM-P PKM METAL CABLE GLAND

BASE

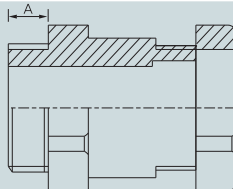
MODEL AND SIZE

Article No.	Thread Dimension	Clamping range (mm)	A (mm)	Wrench size (mm)
BC-PKM-P7	PG7	6 ~ 8	5	15
BC-PKM-P9	PG9	8 ~ 10	6	17
BC-PKM-P11	PG11	10 ~ 12	6	22
BC-PKM-P13	PG13.5	12 ~ 14	7	24

PRODUCT CHARACTERISTICS

Material : Body : nickel-plated brass Sealing : NBR

Protection degree : Within the clamping range, its protection degree can reach IP65

BC-HSK-EX-P EX PLASTIC CABLE GLAND

BASE

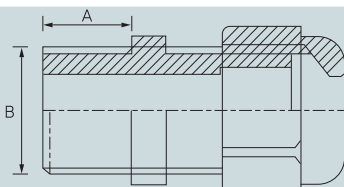
MODEL AND SIZE

Article No.	Clamping range (mm)	A (mm)	B (mm)	Wrench size (mm)
BC-HSK-EX-P7	3 ~ 6.5	8	12.5	15
BC-HSK-EX-P9	4 ~ 8	8	15.2	19
BC-HSK-EX-P11	5 ~ 10	8	18.6	22
BC-HSK-EX-P13	6 ~ 12	9	20.4	24
BC-HSK-EX-P16	8 ~ 14	10	22.5	27
BC-HSK-EX-P21	13 ~ 18	11	28.3	33
BC-HSK-EX-P29	18 ~ 25	11	37	42
BC-HSK-EX-P36	22 ~ 32	13	47	52
BC-HSK-EX-P42	30 ~ 38	14	54	60
BC-HSK-EX-P48	37 ~ 44	15	59.3	65

PRODUCT CHARACTERISTICS

Material : Body : Polymide 66, Sealing : NBR

Color : Grey white (RAL 7035), Black (RAL 9005)

Protection degree : Using suitable O-sealings within the clamping range, its protection degree can reach IP68

Temperature Range : Stat : Min-40°C, Max 100°C, Short-term 120°C
Dyn. : Min-20°C, Max 80°C, Short-term 100°C

Properties : V2(94), free of halogen, phosphor and cadmium passed RoHS UV-resistance, ageing-resistance certificates

EX degree : Exe II T5 Certificate No. : CNE07.0311U

BC-HSM-EX-P EX METAL CABLE GLAND



BASE

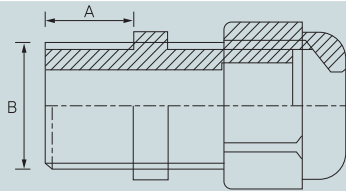

MODEL AND SIZE

Article No.	Thread Dimension	Clamping range (mm)	A (mm)	B (mm)	Wrench size (mm)
BC-HSM-EX-P7	PG7	3 ~ 6,5	5	12,5	14
BC-HSM-EX-P9	PG9	4 ~ 8	6	15,2	17
BC-HSM-EX-P11	PG11	5 ~ 10	6	18,6	20
BC-HSM-EX-P13	PG13.5	6 ~ 12	7	20,4	22
BC-HSM-EX-P16	PG16	8 ~ 14	7	22,5	24
BC-HSM-EX-P21	PG21	13 ~ 18	8	28,3	30
BC-HSM-EX-P29	PG29	18 ~ 25	8	37	40
BC-HSM-EX-P36	PG36	22 ~ 32	9	47	50
BC-HSM-EX-P42	PG42	30 ~ 38	9	54	60
BC-HSM-EX-P48	PG48	37 ~ 44	10	59,3	65

PRODUCT CHARACTERISTICS

Material : Body : Nickel-plated brass seal : Polymide 66, Sealing : NBR
 Protection degree : Within the clamping range, its protection degree can reach IP68.
 Properties : Succeeded in the experiment of IEC-60077-1999 resistance to vibration and impact.
 Temperature Range : Stat : Min-40°C, Max 100°C, Short-term 120°C
 Dyn. : Min-20°C, Max 80°C, Short-term 100°C
 Ex degree : Exe II T5 Certificate No : CNEx07.03126

BC-RG-PG RUBBER GROMMET PG



BASE

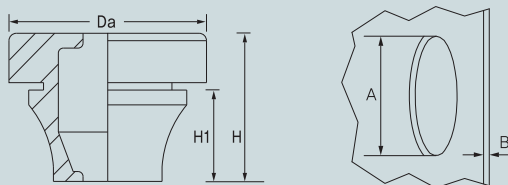

MODEL AND SIZE

Article No.	Thread AD (mm)	Ømm (cable)	A (mm)	B (mm)	Da (mm)	H (mm)	H1 (mm)
BC-RG-PG7	12,5	3 ~ 5	13	0,5 ~ 2	20	12,6	5,4
BC-RG-PG9	15,2	5 ~ 7	16	1 ~ 4	21	17,8	10,3
BC-RG-PG11	18,6	7 ~ 10	19	1 ~ 4	24	19,8	12,7
BC-RG-PG16	22,5	10 ~ 14	23	1 ~ 4	28	21,6	14,7
BC-RG-PG21	28,3	14 ~ 20	29	1 ~ 4	35	24,6	17,6
BC-RG-PG29	37	20 ~ 26	38	1 ~ 4	46	28,5	20
BC-RG-PG36	47	26 ~ 35	48	1 ~ 4	58	34,9	23,9

PRODUCT CHARACTERISTICS

Mode of Protection : IP67 acc. to EN 60529
 Temperature Range : -40°C ... +100°C
 Test standard : EMKO TUI(03-SEC) FI001/84
 Semko report : 410375
 Halogen - Free

BC-SP-PG SCREW PLUG



BASE

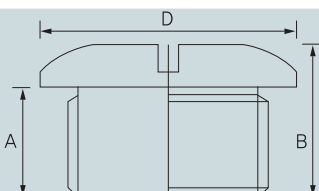

MODEL AND SIZE

Article No.	A (mm)	B (mm)	D (mm)
BC-SP-PG7	8,5	12,5	15
BC-SP-PG9	8,5	13	19
BC-SP-PG11	9	13	22
BC-SP-PG13.5	9	13	25
BC-SP-PG16	10,5	15	27
BC-SP-PG21	8,5	13,5	33
BC-SP-PG29	11,5	16	44
BC-SP-PG36	13,5	18	55
BC-SP-PG42	13,5	18,5	62
BC-SP-PG48	14,5	19,5	68

PRODUCT CHARACTERISTICS

Material : nylon plastic
 Protection degree : IP54
 Ambient temperature : -40°C to 100°C
 Supply color : Grey, Black

BC-MSP-PG METAL SCREW PLUG



BASE

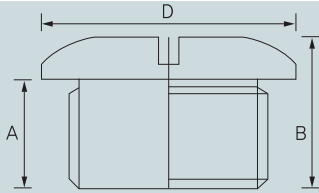

MODEL AND SIZE

Article No.	A (mm)	B (mm)	Wrench size (mm)
BC-MSP-PG7	5	8	14
BC-MSP-PG9	6	9	17
BC-MSP-PG11	6	9	20
BC-MSP-PG13.5	6.5	9.5	22
BC-MSP-PG16	6.5	9.5	24
BC-MSP-PG21	7	11	30
BC-MSP-PG29	8	12	39
BC-MSP-PG36	9	15	50
BC-MSP-PG42	10	16	57
BC-MSP-PG48	10	16	64

PRODUCT CHARACTERISTICS

Material : Nickel-plated brass
 Protection degree : IP68

BC-HP-PG HOLE PLUG

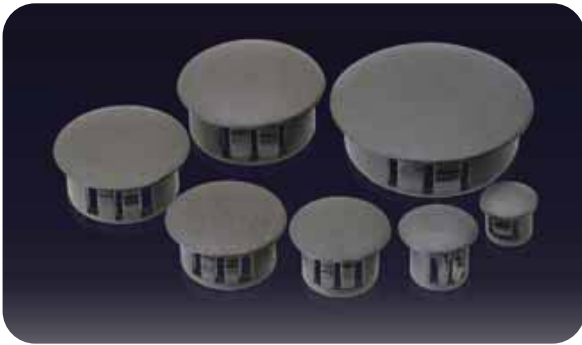

BASE

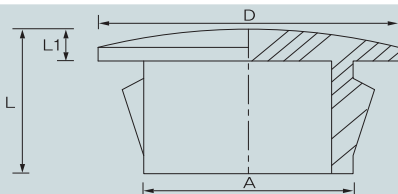

MODEL AND SIZE

Article No.	A	D	L1	L
	Aperture of the steel board	OD of the plug	Thickness	Total length
BC-HP-PG8	7.8	11.9	1.6	8
BC-HP-PG10	9.5	13	1.6	10.5
BC-HP-PG13	12.7	16.9	1.6	10.5
BC-HP-PG16	15.9	19.8	1.6	10.5
BC-HP-PG19	19	22.9	1.6	10.5
BC-HP-PG22	22.2	24.9	1.6	11.5
BC-HP-PG26	25.5	28.3	1.6	11.5
BC-HP-PG30	30	34.2	1.6	11.5

PRODUCT CHARACTERISTICS

Material : PA66, 94-V2
 Color : Black (RAL 9005)
 Temperature Range : Min -40°C, Max 100°C
 Application : To cover the spares holes, by pushing the plug with your hand, you can finish the assembly easily without additional tools, suitable for the steel board below 3.2mm

BC-DPM-P HEXAGON PLUG



BASE

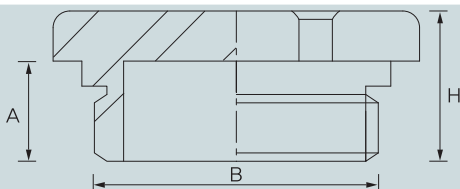

MODEL AND SIZE

Article No.	Thread Dimension	A (mm)	B (mm)	Wrench size (mm)	H (mm)
BC-DPM-P7	PG7	5	12.5	14	8
BC-DPM-P9	PG9	6	15.2	17	9
BC-DPM-P11	PG11	6	18.6	20	9
BC-DPM-P13	PG13.5	7	20.4	22	10
BC-DPM-P16	PG16	7	22.5	24	10
BC-DPM-P21	PG21	7	28.3	30	11
BC-DPM-P29	PG29	8	37	40	12
BC-DPM-P36	PG36	9	47	50	15
BC-DPM-P42	PG42	10	54	60	16
BC-DPM-P48	PG48	10	59.3	65	16

PRODUCT CHARACTERISTICS

Material : Nickel-plated brass
 Protection degree : IP68

BC-M CABLE GLAND



BASE

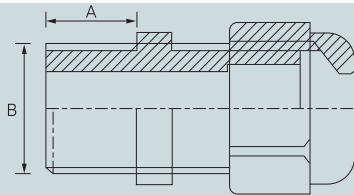

MODEL AND SIZE

Model No.	Size (Cable Ø)	A (mm)	B (mm)
BC-M-12	3 ~ 6.5	8	12
BC-M-16	4 ~ 8	8	16
BC-M-20	6 ~ 12	9	20
BC-M-25	13 ~ 18	11	25
BC-M-32	18 ~ 25	11	32
BC-M-40	22 ~ 32	13	40
BC-M-50	32 ~ 38	13	50
BC-M-63	37 ~ 44	14	63

PRODUCT CHARACTERISTICS

Material : Nylon plastic
 Hermetic seal: Nitrile rubber
 IP rating: IP66
 Ambient temperature : -20°C ~ 65°C

BC-BP-M BEND PROOF CABLE GLAND



BASE



MODEL AND SIZE

Model No.	Size (Cable Ø)	A (mm)	B (mm)
BC-BP-M-12	3 ~ 6.5	8	12
BC-BP-M-16	4 ~ 8	8	16
BC-BP-M-20	6 ~ 12	9	20
BC-BP-M-25	13 ~ 18	11	25

PRODUCT CHARACTERISTICS

Material : Nylon plastic
 Hermetic seal: Nitrile rubber
 Ambient temperature : quiescent state -40°C to 100°C, short time to 120°C, dynamic -20°C to 80°C, short time to 100°C
 Supply color : Grey

BC-MM METAL CABLE GLAND



BASE

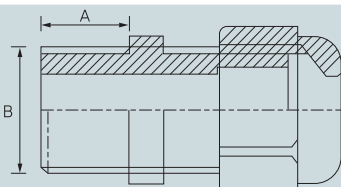

MODEL AND SIZE

Model No.	Size (Cable Ø)	A (mm)	B (mm)
BC-MM-12	3 ~ 6.5	6.5	12
BC-MM-16	4 ~ 8	6	16
BC-MM-20	6 ~ 12	6	20
BC-MM-25	13 ~ 18	7	25
BC-MM-32	18 ~ 25	8	32
BC-MM-40	22 ~ 32	8	40
BC-MM-50	32 ~ 38	9	50
BC-MM-63	37 ~ 44	10	63

PRODUCT CHARACTERISTICS

Material : Body : nickel-plated brass Seal : Polyimide 66, Sealing : NBR
 Protection degree: within the clamping range, its protection degree can reach IP68.
 Properties : succeed in the experiment of IEC-60077-1999 resistance to vibration and impact.
 Temperature range : Stat: Min -40°C, Max 100°C, Short-term 120°C
 Dyn. : Min -20°C, Max 80°C, Short-term 100°C

BC-SP-M SCREW PLUG



MODEL AND SIZE

Article No.	A (mm)	B (mm)	D (mm)
BC-SP-M-12	8,5	12,5	15
BC-SP-M-16	8,5	13	19
BC-SP-M-18	9	13	22
BC-SP-M-20	9	13	25
BC-SP-M-22	10,5	15	27
BC-SP-M-25	10,5	15,5	30
BC-SP-M-27	10,5	15,5	33
BC-SP-M-32	10,5	16	38
BC-SP-M-40	11,5	16	46
BC-SP-M-50	13,5	18	56
BC-SP-M-63	14	19	68

BASE

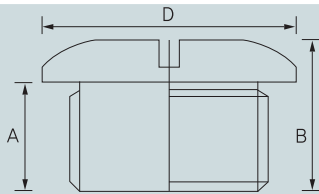

PRODUCT CHARACTERISTICS

Material : Nylon plastic
 Protection degree : IP54
 Ambient temperature : -40°C to 100°C
 Supply color : Grey, Black

BC-MSP-M METAL SCREW PLUG



MODEL AND SIZE

Article No.	A (mm)	B (mm)	Wrench size (mm)
BC-MSP-M12	5	8	14
BC-MSP-M16	6	9	18
BC-MSP-M18	6	9	20
BC-MSP-M20	6,5	9,5	22
BC-MSP-M22	6,5	9,5	24
BC-MSP-M25	7	11	28
BC-MSP-M32	8	12	35
BC-MSP-M40	9	15	44
BC-MSP-M50	10	16	54
BC-MSP-M63	10	16	70

BASE

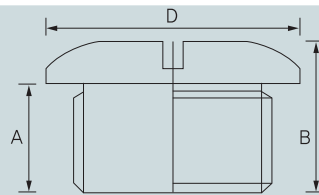

PRODUCT CHARACTERISTICS

Material : Nickel-plated brass
 Protection degree : IP68



BC-V60, V80 VENT

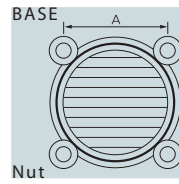

MODEL AND SIZE

Article No.	A	Processing Size	Ventilation Fan Size
BC-V 60	50 ± 0.3 mm	63 ~ 65 ∅	60 ∅
BC-V 80	71.5 ± 0.3 mm	88 ~ 90 ∅	80 ∅

PRODUCT CHARACTERISTICS

1. It is easy to dissipate heat from inside of box to outside.
2. It is easy to install cooling fan inside the box.
3. It is designed to prevent penetration of rain.

DRAW LATCH

Material : SUS 304
BC-L75

BC-L65

BC-L55

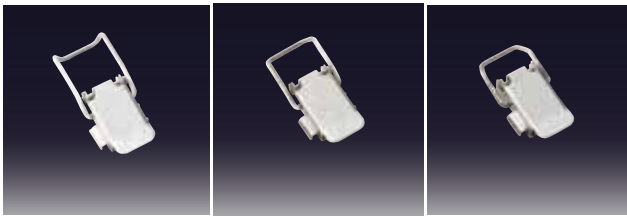

DRAW LATCH LOCK

Material : SUS 304

Use only P-type

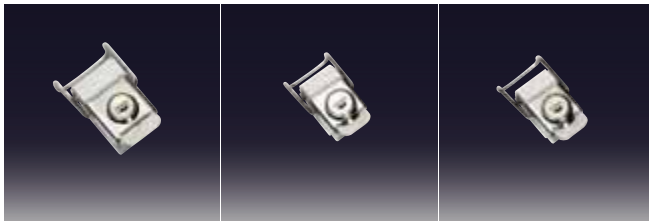

HINGE

Material : SUS 304
BC-H75

BC-H65

BC-H55

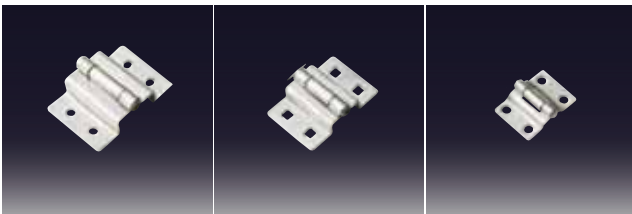

DUAL DOOR

Material : ABS
Including : frame, pillar, hinge, handle



WALL MOUNTING BRACKET

Material : SUS 304
BC-B60

BC-B50

BC-B40

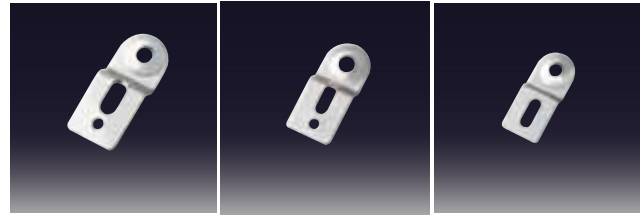

PLASTIC BRACKET

Material : PC/ABS
PB25

PB20

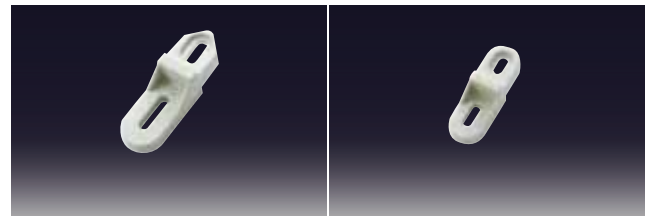

DUCT RING

Material : Steel (zinc plating)

BC-D30L

BC-D30S

BC-D25L

BC-D25S

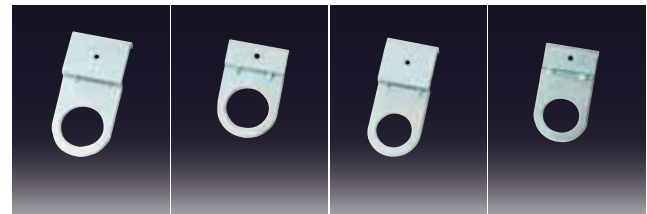

PLASTIC BRACKET

Material : SUS 304

BC-ES



PLASTIC LOCK

Material : Nylon

Available for all hinge type enclosure

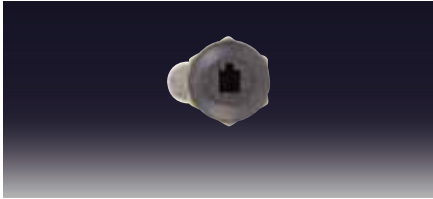
**LOCK**

Material : SUS 304 etc.

Available for all hinge type enclosure

**KEY RING**

Material : SUS 304

Available for all hinge type enclosure

**COVER BOLT**

Material : ABS

CB 20-

CB 20

CB 28-

CB 28

CB 35

CB 50

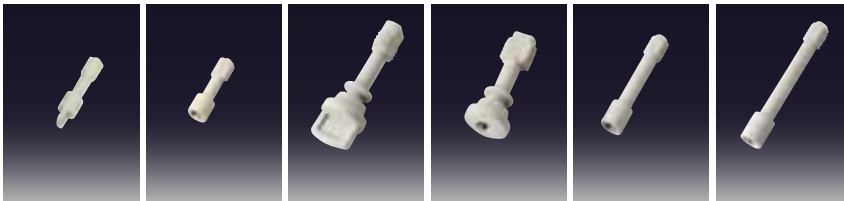
**DUAL DOOR MOUNTING PLATE**

Material : Aluminium

Medium and large plastic enclosure

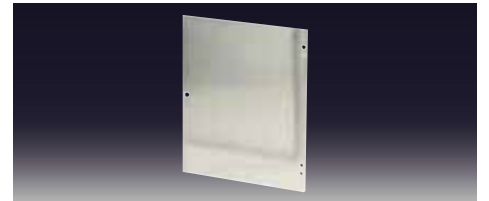
**PLASTIC MOUNTING PLATE**

Material : ABS

All of plastic enclosure

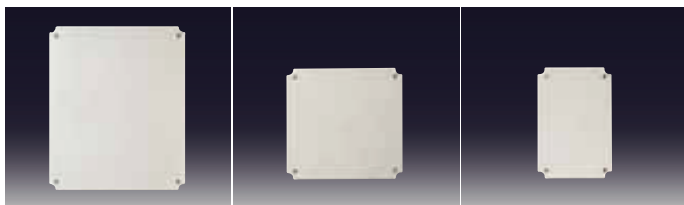
**STEEL MOUNTING PLATE**

Material : Steel (Zinc plating)

All of plastic and aluminium enclosure

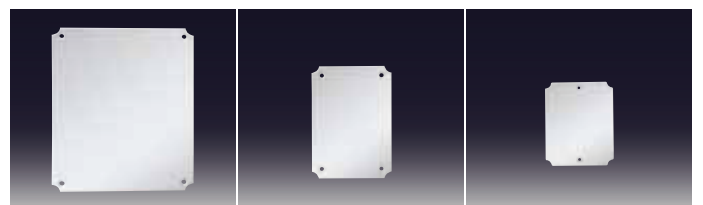



OFFICE ADDRESS
9E PIERMARK DRIVE
ALBANY, AUCKLAND
NEW ZEALAND

POSTAL ADDRESS
PO Box 305489
TRITON PLAZA
ALBANY, AUCKLAND
NEW ZEALAND

PHONE: +64 9 477 0177

Fax: +64 9 479 9163

Online Catalogue: nz.wellforces.com

Online Resources: nz.wellforces.com/resources

contact@wellforces.co.nz

 www.facebook.com/wellforces

 [@Wellforces](https://twitter.com/Wellforces)

