

SECTION A-A

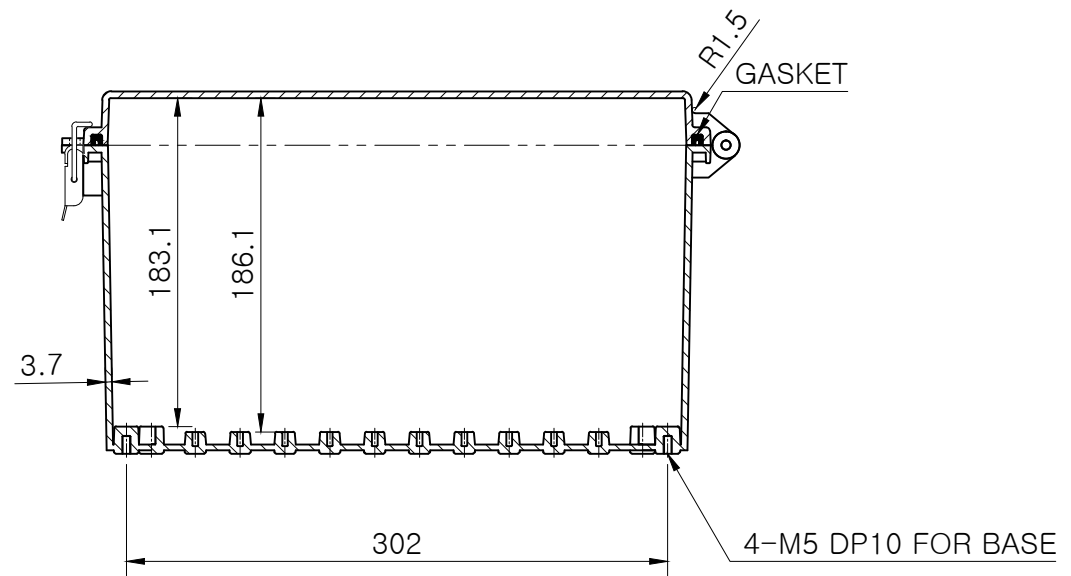
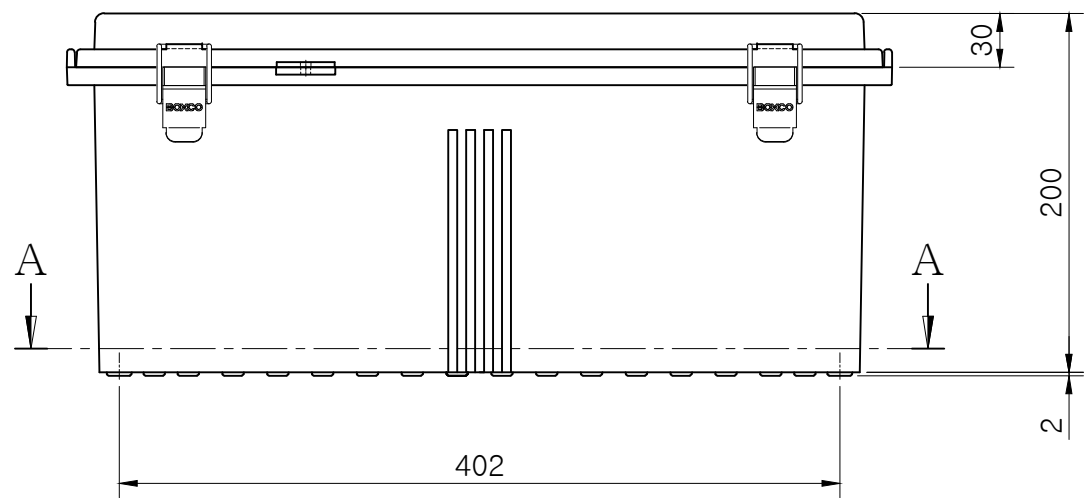

SECTION B-B

Note.

MODEL (모델)	BC-□□P-354520	DR (제도)	JUNG,Y.J.	16.04.24	UNIT (단위)	mm	
ASSY (완성 규격)	350 * 450 * 200	CK (검도)	PARK,Y.J.	16.04.24	SCALE (척도)	1:4	
DWG NO (도번)	P-354520-03	MATERIAL (재질)	AP (승인)	KIM,D.S.	16.04.25	REV. (개정)	0

BOXCO[®]